

TX-G10 Service Manual

Safety

Specifications

Parts List

Service
Information

Adjustments

Self Check

Service Hints

Mechanical
View

Disassembly

Location of
Controls

Waveforms

Block Diagrams

Schematic Diagrams

PCB Views

Service Support

Service and repair of this product is supported by Panasonic's LUCI interface.

This interface provides a link between the TV and a standard PC to allow a number of diagnostic and control functions to be performed.

For more details contact your local Panasonic company.

BACK

EXIT

Audio

Control

Power supply

Video



BACK

E - PCB

Q - PCB

Y - PCB



BACK

E - Schematic

Q - Schematic

Y - Schematic



BACK

Service Manual



Portable Colour Television

TX-G10

AC1 Chassis

SPECIFICATIONS

Power Source:	220-240V a.c., 50Hz 12-24V d.c.
Power Consumption:	39W
Aerial Impedance:	75Ω unbalanced, Coaxial Type
Stand-by Power Consumption:	1W
Receiving System:	PAL-I, B/G, H, D/K, PAL-525/60 SECAM L/L' B/G, D/K M.NTSC, NTSC (AV only)
Intermediate Frequency:	Video 39,5MHz, 38,9MHz, 34MHz Sound 32,9MHz, 33,4MHz, 33,16MHz 32,4MHz, 40,4MHz Colour 34,47MHz (PAL) 34,5MHz, 34,65MHz (SECAM)
Receiving Channels:	VHF E2-E12 VHF H1-H2 (ITALY) VHF A-H (ITALY) VHF R1-R2 VHF R3-R5 VHF R6-R12 UHF E21-E69 CATV (S01-S05) CATV S1-S10 (M1-M10) CATV S11-S20 (U1-U10) CATV S21-S41 (HYPERBAND)
Video/Audio Terminals:	
AV1 IN	Video (21 pin) 1V p-p 75Ω Audio (21 pin) 500mV rms 10kΩ
AV1 IN (Front)	Audio (RCAx1) 500mV rms 10kΩ Video (RCAx1) 1V p-p 75Ω S-Video IN Y: 1V p-p 75Ω (4 pin) C: 0.3V p-p 75Ω
AV1 OUT	Video (21 pin) 1V p-p 75Ω Audio (21 pin) 500mV rms 1kΩ

AV2 IN	Audio (RCAx1) 500mV rms 10kΩ Video (BNCx1) 1V p-p 75Ω
AV2 OUT	Audio Monitor Out Video Monitor Out
High Voltage:	20kV +0,7kV/-1kV
Picture Tube:	A23KQU22X01
Audio Output:	3,5W (Music Power) 8Ω Impedance
Headphones:	8Ω Impedance 3,5 mm
Accessories supplied :	Remote Control 2 x R6 (UM3) Batteries
Dimensions:	
Height:	272 mm
Width:	283 mm
Depth:	309 mm
Net weight:	7kg

Specifications are subject to change without notice.
Weights and dimensions shown are approximate.

NOTE: This Service Manual should be used in conjunction with the AC1 Technical Guide.

CONTENTS

SAFETY PRECAUTIONS.....	2
SERVICE HINTS.....	3
SERVICE POSITION.....	4
ADJUSTMENT PROCEDURE.....	5
WAVEFORM PATTERN TABLE.....	6
ALIGNMENT SETTINGS.....	7
BLOCK DIAGRAMS.....	8
PARTS LOCATION.....	12
REPLACEMENT PARTS LIST.....	13
SCHEMATIC DIAGRAMS.....	22
CONDUCTOR VIEWS.....	25

SAFETY PRECAUTIONS

GENERAL GUIDE LINES

1. It is advisable to insert an isolation transformer in the a.c. supply before servicing a hot chassis.
2. When servicing, observe the original lead dress in the high voltage circuits. If a short circuit is found, replace all parts that have been overheated or damaged by the short circuit.
3. After servicing, see that all the protective devices such as insulation barriers, insulation papers, shields and isolation R-C combinations are correctly installed.
4. When the receiver is not being used for a long period of time, unplug the power cord from the a.c. outlet.
5. Potentials as high as 20,7kV are present when this receiver is in operation. Operation of the receiver without the rear cover involves the danger of a shock hazard from the receiver power supply. Servicing should not be attempted by anyone who is not familiar with the precautions necessary when working on high voltage equipment. Always discharge the anode of the tube.
6. After servicing make the following leakage current checks to prevent the customer from being exposed to shock hazard.

LEAKAGE CURRENT COLD CHECK

1. Unplug the a.c. cord and connect a jumper between the two prongs of the plug.
2. Turn on the receiver's power switch.
3. Measure the resistance value with an ohmmeter, between the jumpered a.c. plug and each exposed metallic cabinet part on the receiver, such as screw heads, aerials, connectors, control shafts etc. When the exposed metallic part has a return path to the chassis, the reading should be between 4M ohm and 20M ohm. When the exposed metal does not have a return path to the chassis, the reading must be infinite.

LEAKAGE CURRENT HOT CHECK

1. Plug the a.c. cord directly into the a.c. outlet. Do not use an isolation transformer for this check.
2. Connect a 2kΩ 10W resistor in series with an exposed metallic part on the receiver and an earth, such as a water pipe.
3. Use an a.c. voltmeter with high impedance to measure the potential across the resistor.
4. Check each exposed metallic part and check the voltage at each point.
5. Reverse the a.c. plug at the outlet and repeat each of the above measurements.

6. The potential at any point should not exceed 1,4 Vrms. In case a measurement is outside the limits specified, there is a possibility of a shock hazard, and the receiver should be repaired and rechecked before it is returned to the customer.

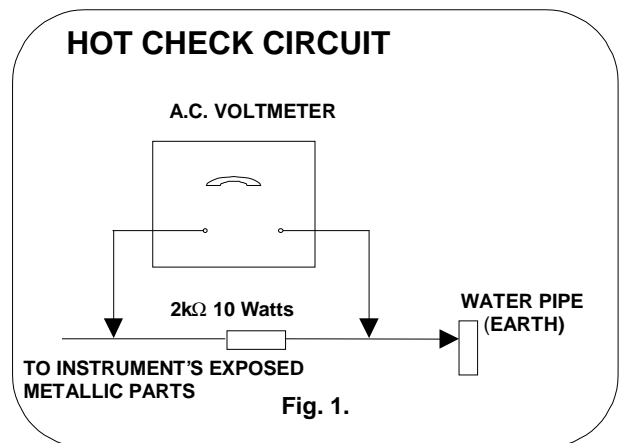

X-RADIATION WARNING

1. The potential sources of X-Radiation in TV sets are the high voltage section and the picture tube.
2. When using a picture tube test jig for service, ensure that the jig is capable of handling 20,7kV without causing X-Radiation.

NOTE: It is important to use an accurate periodically calibrated high voltage meter.

1. Set the brightness to minimum.
2. Measure the high voltage. The meter should indicate :- 20kV +0,7kV/-1kV If the meter indication is out of tolerance, immediate service and correction is required to prevent the possibility of premature component failure.
3. To prevent any X-Radiation possibility, it is essential to use the specified tube.

SERVICE HINTS

How to remove the rear cover

1. Remove the 7 screws as shown in **Fig.2**.
2. Push clips **(A)** and elevate lid.
3. Remove the 2 screws as shown in **Fig.3**.



SCREWS
Fig.2.



SCREWS
Fig.3.

LOCATION OF CONTROLS

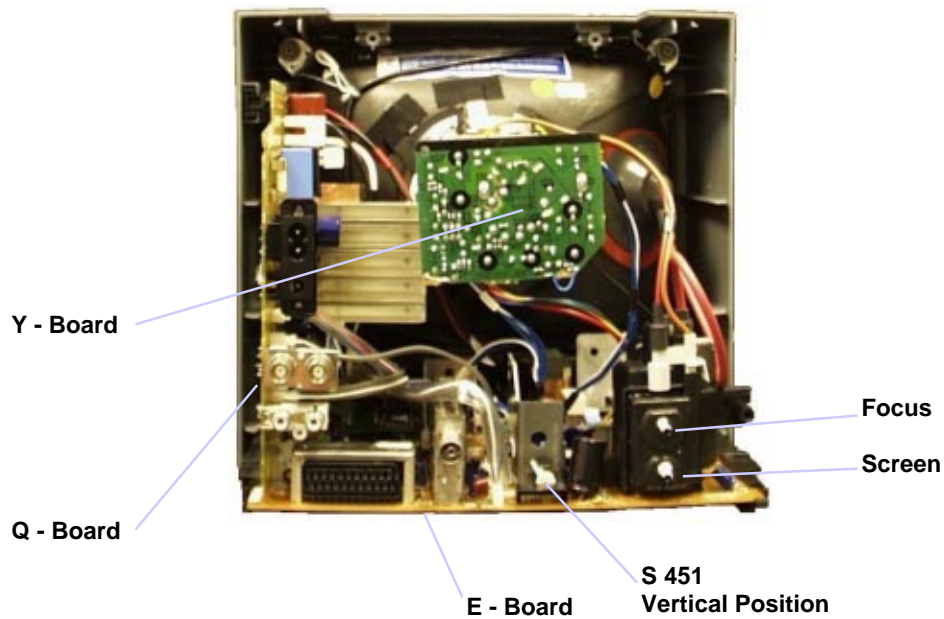

Fig.4.

HOW TO MOVE THE CHASSIS INTO SERVICE POSITION

1. Remove the backcover screws and clips as shown in **Fig.2** and **Fig.3** (page3.).
2. Release chassis from right-hand chassis rail and partially withdraw.
3. Rotate, clockwise, the whole T.V. vertically through 90°.
4. After servicing ensure all wiring is returned to its original position before returning the receiver to the customer.

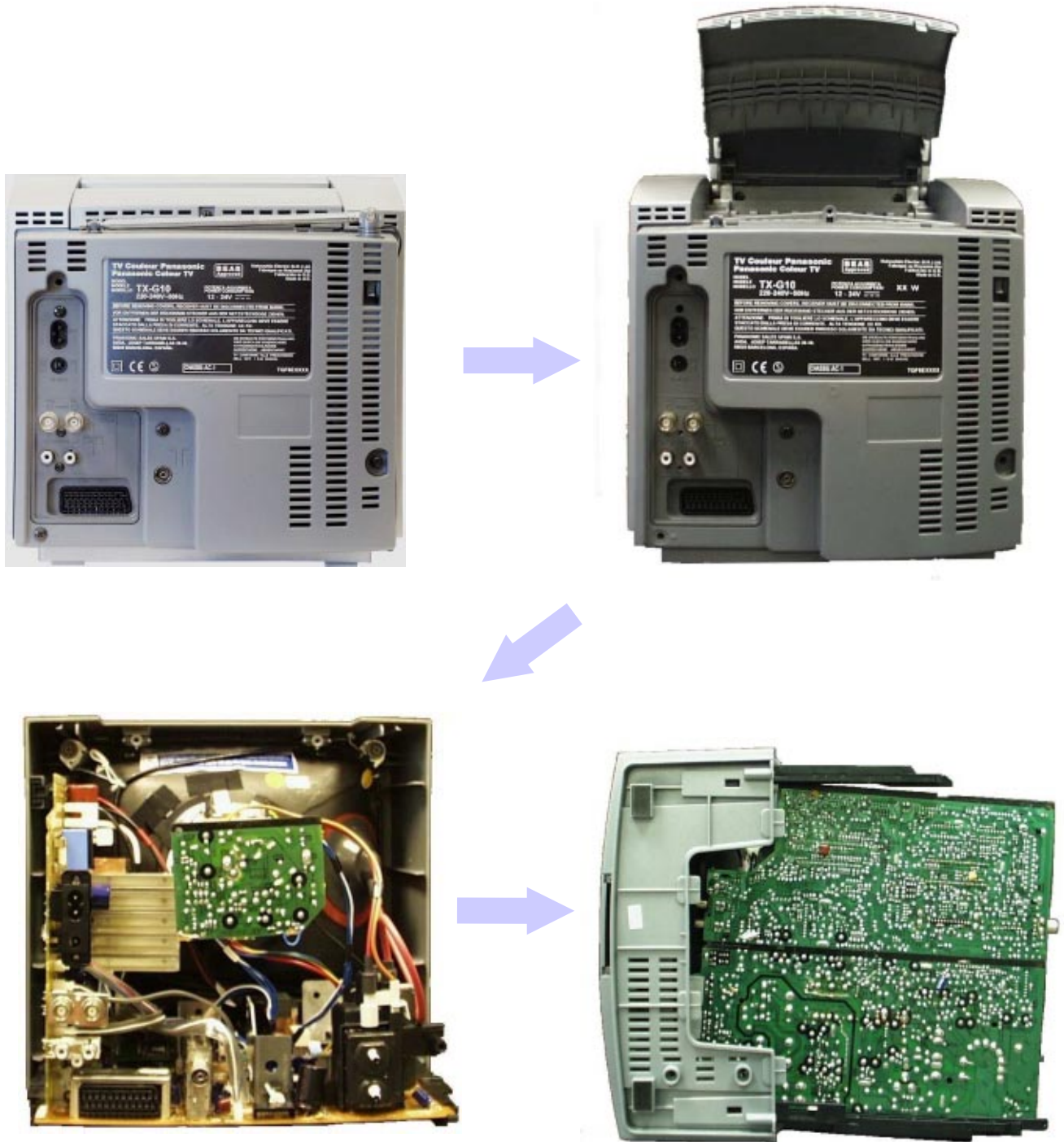

Fig.5.

ADJUSTMENT PROCEDURE

Item / Preparation	Adjustments
+B SET-UP 1. Receive a Greyscale signal. 2. Set the controls :- Brightness Minimum Contrast Minimum Volume Minimum	1. Confirm the following voltages. TPE2 130 ± 4V TPE3 8 ± 0,5V TPE4 12 ± 0,7V TPE11 110 ± 10V TPE6 5 ± 0,3V TPE10 23,5 ± 1,5V TPE5 9 ± 0,5V TPE18 320 ± 2V TPE1 13,5 ± 1V TPE13 31 ± 1,5V TPE7 5 ± 0,3V TPE19 16,5 ± 1V
DC Alignment 1. Confirm and note, in a.c. mode, TPE2 .	1. Using a 23V d.c. power supply, adjust R3870 until TPQ28 measures the same as TPE2 . 2. Adjust the d.c. power supply to be 12,8V at F3851 . 3. Confirm TPQ28 measures the same as TPE2
1. Confirm and note, in a.c. mode, TPE1 .	1. Using a 12,8V d.c. power supply, confirm that TPQ27 measures the same as TPE1 .

Service Aids

To aid in the service of our current chassis there are a number of Service Aids which have been made available.

- **LUCI** interface kit (Linked **U**tility **C**omputer **I**nterface)

Part number: TZS6EZ002

This contains interface and cables for connecting TV service connector and a PC as well as diagnostic software. As new models are introduced upgrade software will become available.

- **VICI** (**V**isual **I**nteractive **C**omputer **I**nformation)

These C.D.'s contain multimedia documentation providing quick access to service information.

Part No. TZS7EZ006 & TZS7EZ005

1. Service Manuals
2. Instruction Books
3. Technical Information

- **TASMIN** (**T**echnically **A**dvanced **S**ystem for **M**ultimedia **I**nteractive **N**otes)

As well as providing a first step towards more interactive training this product also achieves quick access to Technical Information.

WAVEFORM PATTERN TABLE

NOTE: All waveforms have been taken using a standard colour bar pattern.

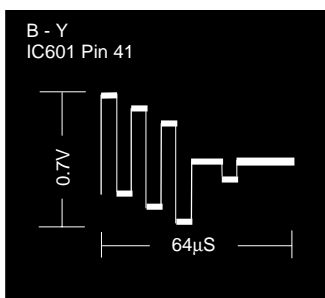
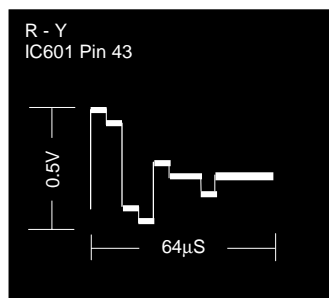
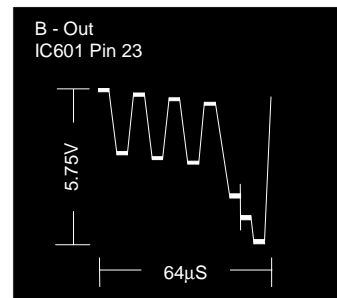
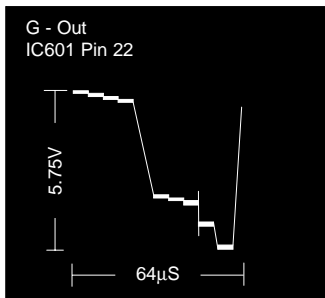
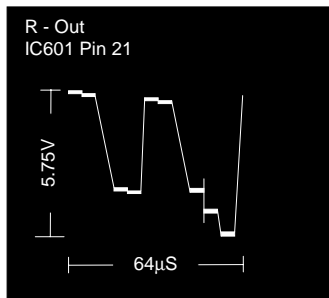
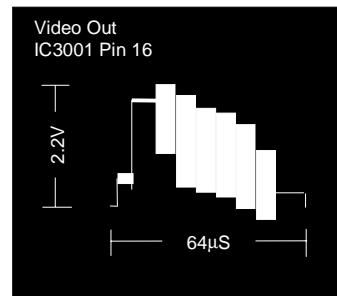
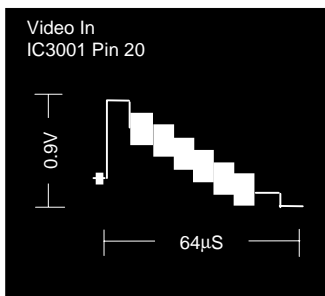
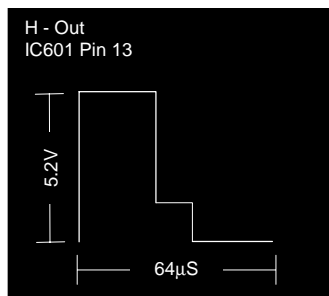
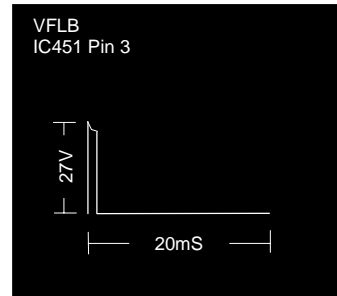
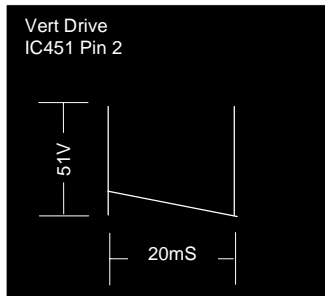
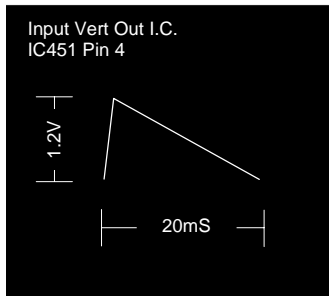

ALIGNMENT SETTINGS

1. To place the TV into Service Mode, set the **Sharpness** to minimum position, place set in program position 60, press the down button (**v**) on the customer controls at the front of the TV and at the same time press the **Off Timer** button on the remote control.
2. Press **^ / v** buttons to step up / down through the functions.
3. Press (**+ / -**) buttons to alter the function values.
4. Press the **TV/AV** button after each adjustment has been made to store the required values.
5. To exit the Service Mode, press the **"N"** button.

(The figures below are nominal and used for representative purposes only.)

Alignment Function		Settings / Special features
Vert. Amplitude	VAmp 56	Optimum setting.
Horizontal Centre	HCtr 09	Optimum setting.
Red Cutoff	RCut 159	Optimum setting.
Green Cutoff	GCut 64	Optimum setting.
Blue Cutoff	BCut 182	Optimum setting.
Red Drive	RDrv 38	Optimum setting.
Blue Drive	BDrv 29	Optimum setting.
Sub-Contrast	SCon 22	Optimum setting.
Sub-Colour	SCol 48	Optimum setting.
Sub-Brightness	SBri 49	Optimum setting.

VIDEO BLOCK DIAGRAM

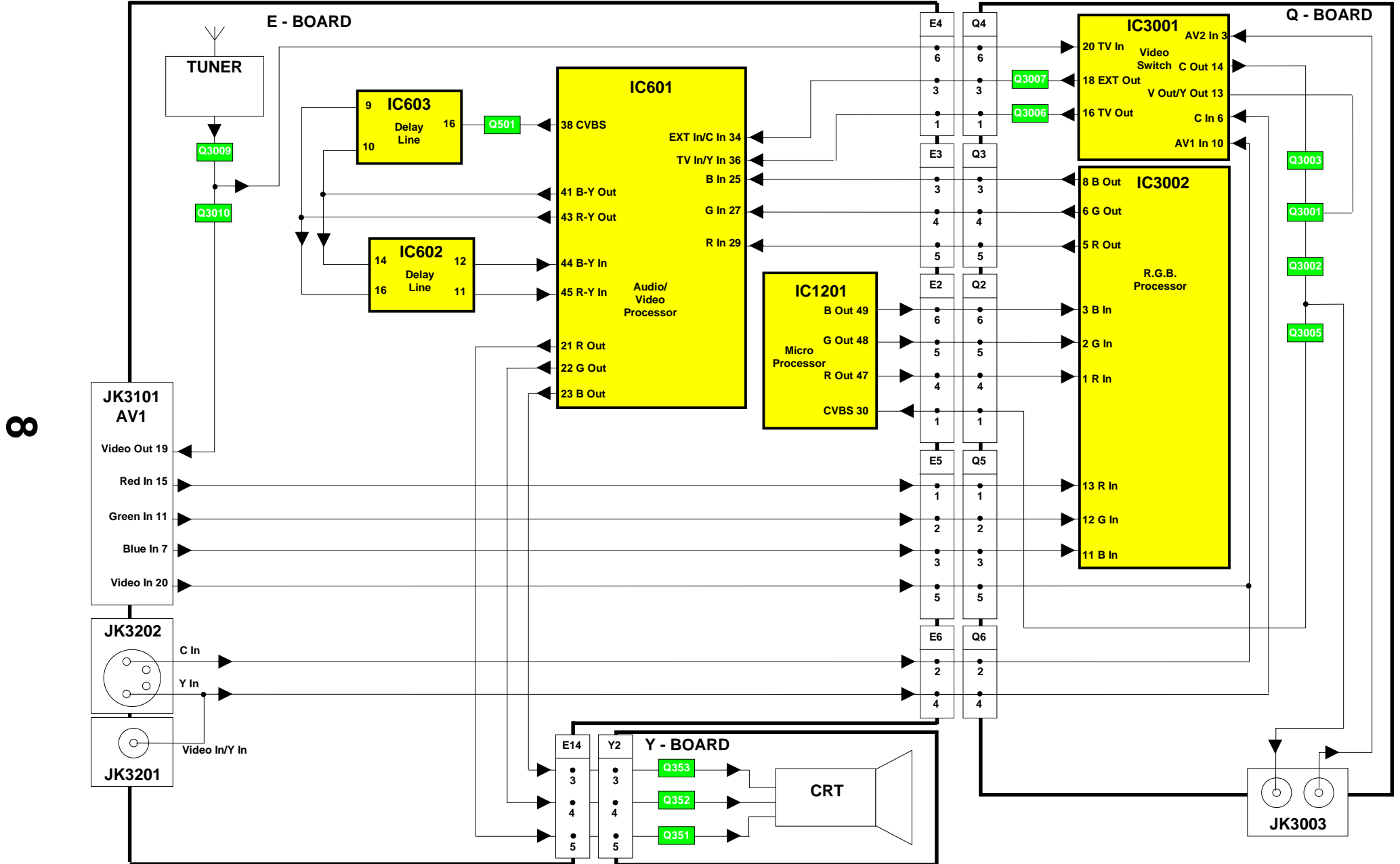

AUDIO BLOCK DIAGRAM

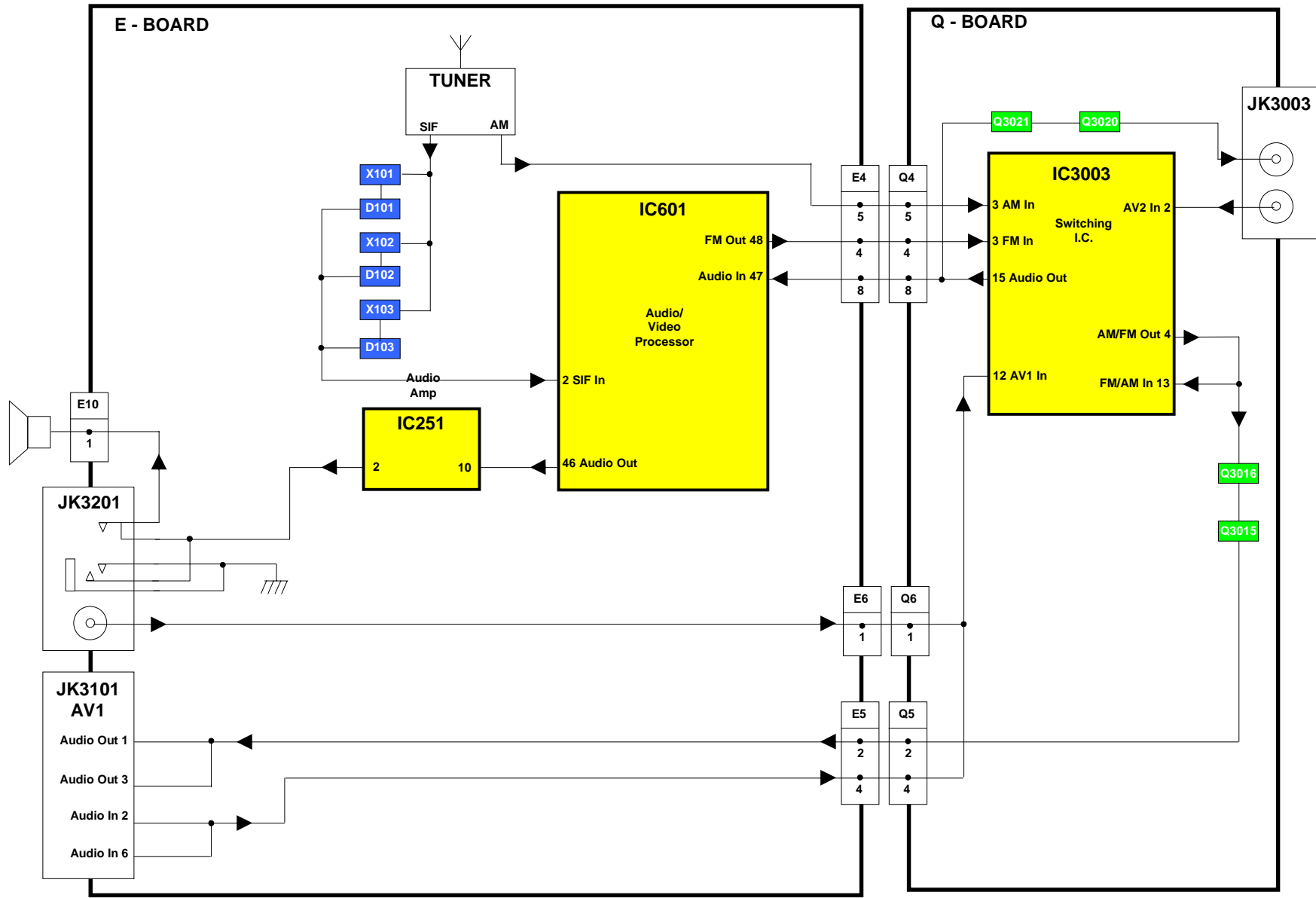

6

CONTROL BLOCK DIAGRAM

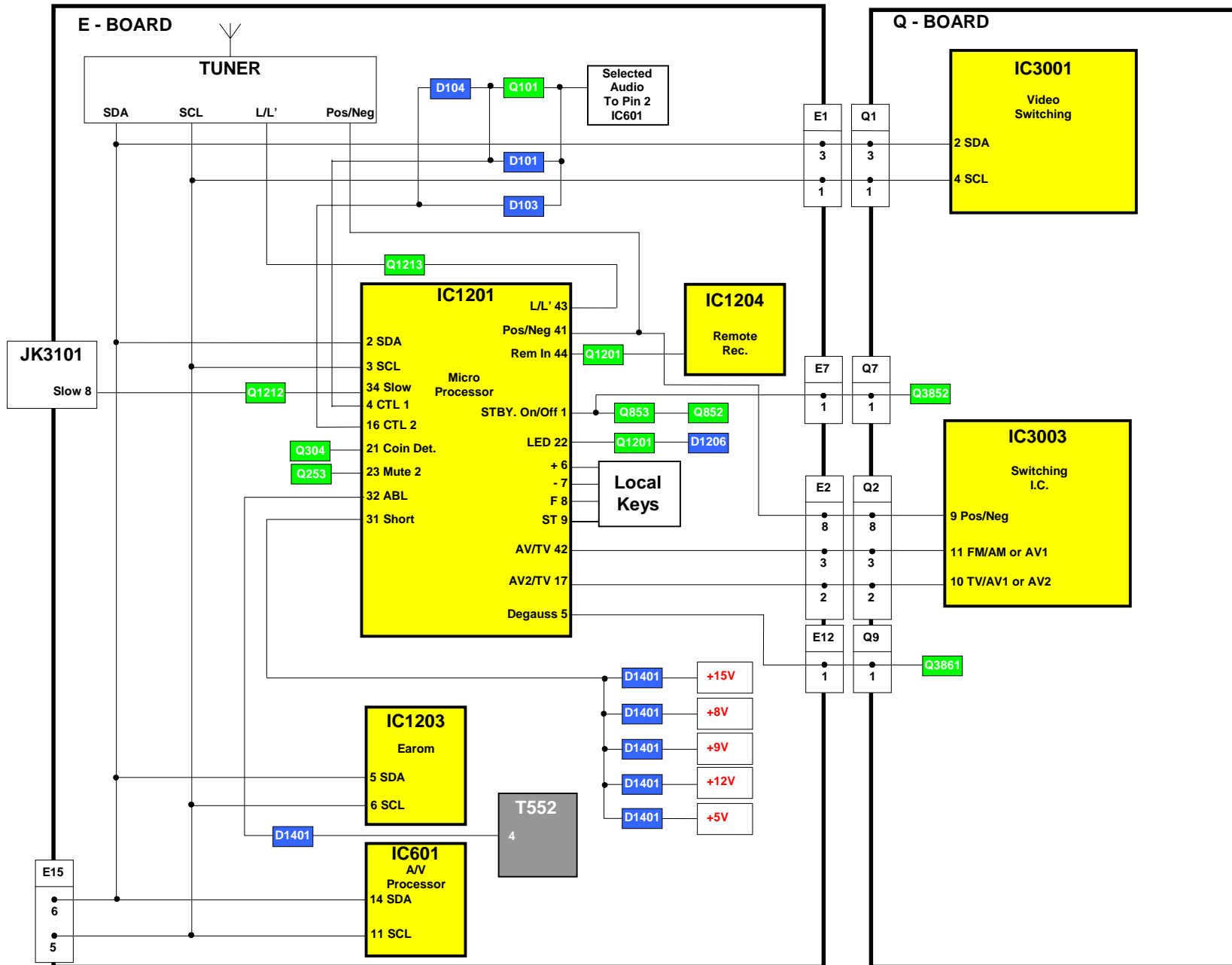

POWER SUPPLY BLOCK DIAGRAM

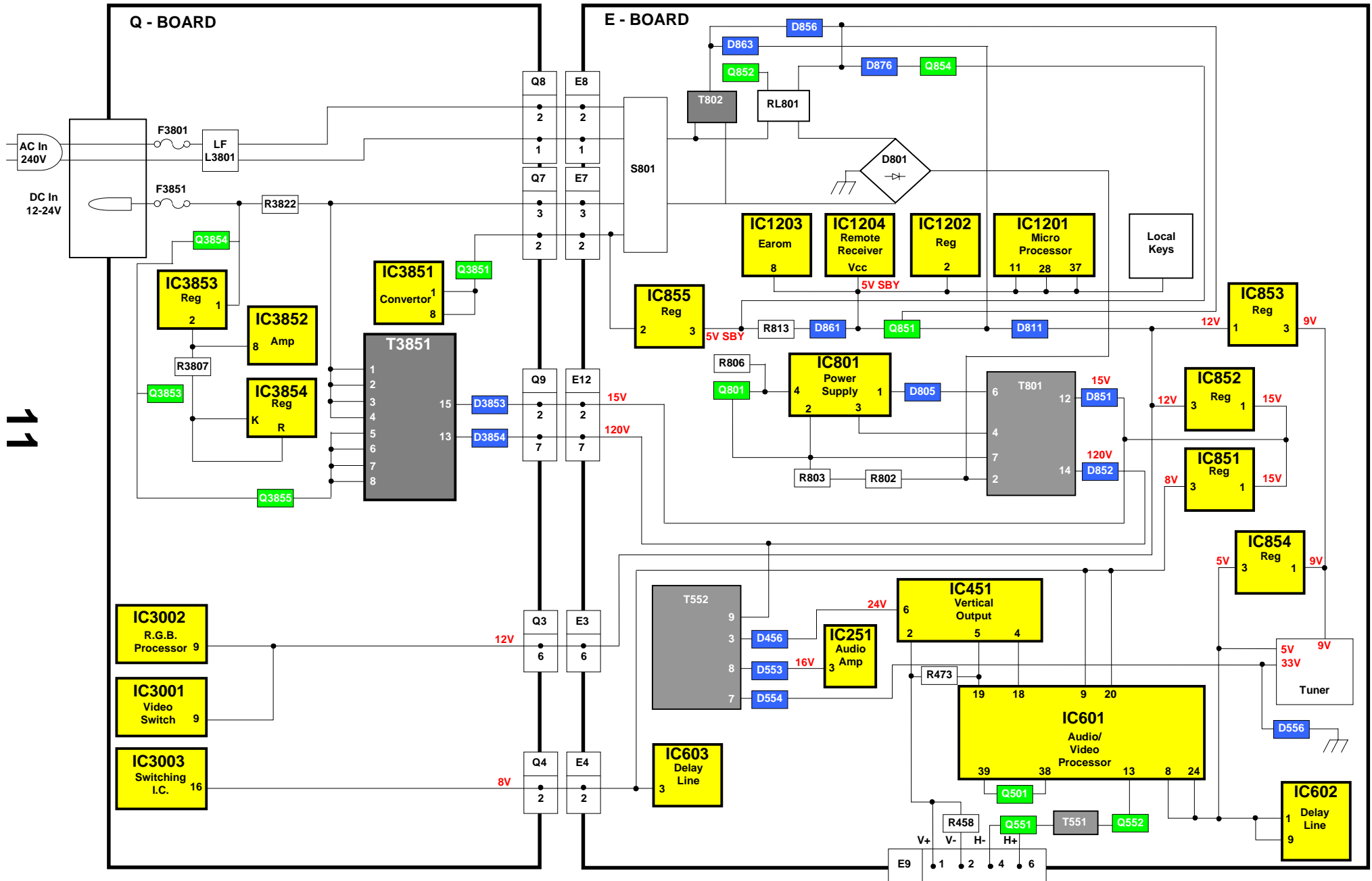

11

PARTS LOCATION

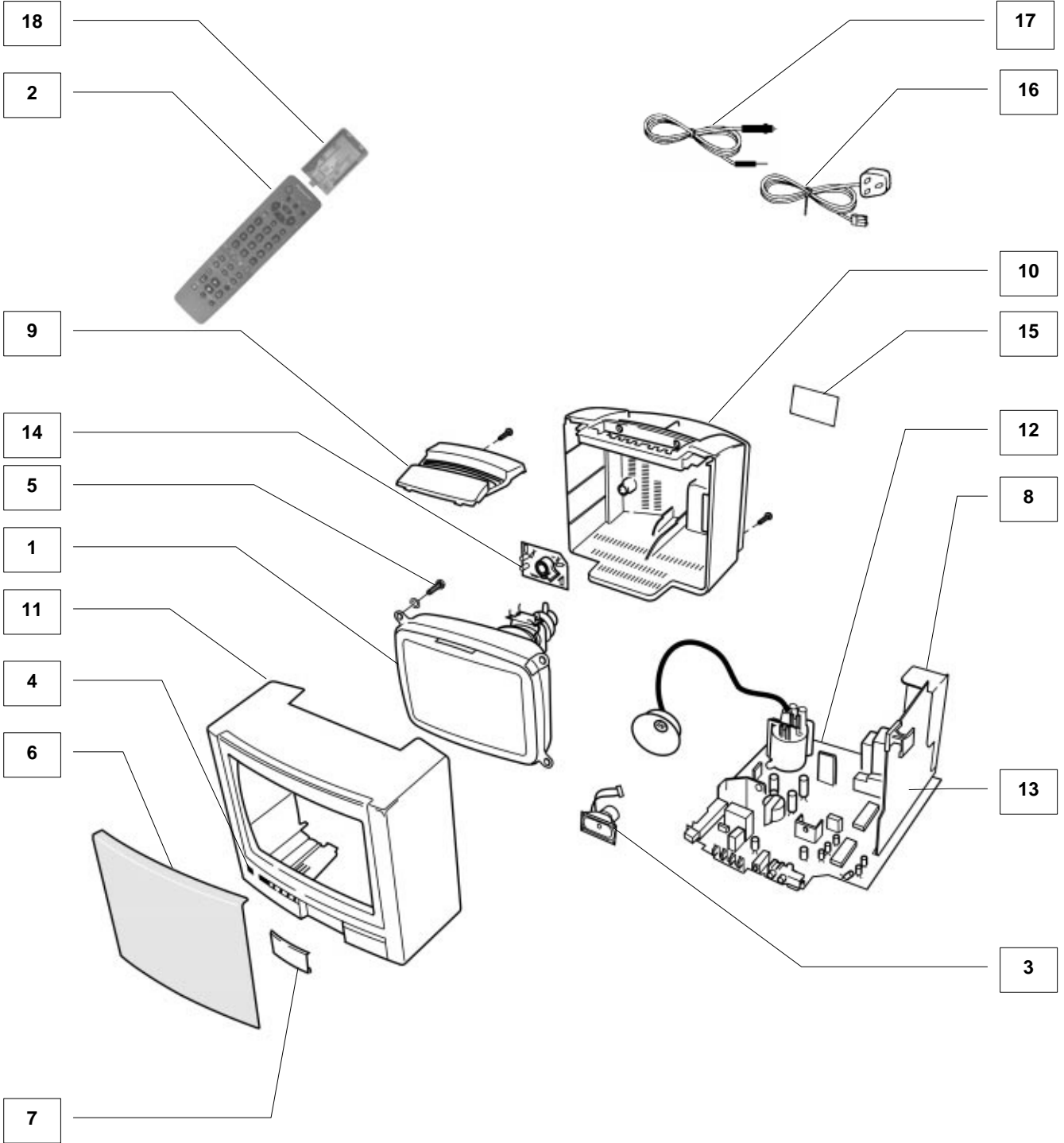

NOTE:
The numbers on the exploded view below refer to the mechanical section of the Replacement Parts List.



REPLACEMENT PARTS LIST

Important Safety Notice

Components Identified by  mark have special characteristics important for safety.
 * When replacing any of these components, use only manufacturers specified parts.
 In case of ordering these spare parts, please always add the complete Model-Type number to your order.

Cct Ref	Parts Number	Description	
MECHANICAL PARTS			
1	A23KQU22X01	C.R.T.	
2	EUR511300	REMOTE CONTROL	
3	F20304813PC	SPEAKER	
4	TBX8E062	POWER BUTTON	
5	THT8E002	C.R.T. FIXING SCREW	
6	TKG8E001	VISOR	
7	TKP8E1230	DOOR LID	
8	TKP8E1232	REAR AV PANEL	
9	TKR8E004	BACK PANEL TOP	
10	TKU8E00390	BACK COVER	
11	TKY8E320	CABINET	
12	TNP8EE010AA	E P.C.B.	
13	TNP8EQ001AA	Q P.C.B.	
14	TNP8EY014AA	Y P.C.B.	
15	TQF8E2672	MODEL LABEL	
16	TSX8E0029	POWER CORD AC	
17	TSX8E0037	POWER CORD DC	
18	UR51EC904A	BATTERY COVER (REMOTE)	
MISCELLANEOUS COMPONENTS			
	31221212478	FIX CLIP	
	F9-4-220	RELAY	
	F9-4-220D-1R	HEAT SINK	
	TBM8E1812	PREST LABEL	
	TBX8E053	KEY PAD	
	TEK6940	LID CATCH	
	TKD8E003	HANDLE SLEEVE	
	TKK8E029	HANDLE COVER (T)	
	TKK8E030	HANDLE COVER (B)	
	TKP8E1231	LED PANEL	
	TKP8E1234	LIGHT PIPE	
	TKR8E005	HANDLE PILLAR (L)	
	TKR8E006	HANDLE PILLAR (R)	
	TKR8E007	HANDLE HINGES	
	TLK8E05144	DEGUASS COIL	
	TMW8E029	LED HOLDER	
	TMX8E024	PCB SUPPORT	
	TMZ8E004	CHASSIS RAIL (R)	
	TMZ8E005	CHASSIS RAIL (L)	
	TPC8E4679	OUTER CARTON	
	TPD8E662	CUSHION TOP	
	TPD8E663	CUSHION BOTTOM	
	TQB8E2730	INSERT SHEET	
	TSA8E006	ANTENNA	
	UM-3DJ-2P	BATTERY PACK	
MOE2	31221212478	FIX CLIP	
RL801	TSE1885-1	RELAY	
S351	0330660069	CRT SOCKET	
TNR1	TACZ9-021A	TUNER	
INSTRUCTION BOOKS			
	TQB8E2573-2	ENGLISH	

Cct Ref	Parts Number	Description	
I.C.s			
IC251	LA4265	AUDIO OUTPUT	
IC451	LA7840	VERTICAL OUTPUT	
IC601	M52779SP	AUDIO/VIDEO PROCESSOR	
IC602	U3666M-MDP	DELAY LINE	
IC603	TDA8395PN2	SECAM DECODER	
IC801	STR54041LF2	POWER SUPPLY	
IC851	AN78M08LB	8V REGULATOR	
IC852	BA12T-M3	12V REGULATOR	
IC853	AN7809LB	9V REGULATOR	
IC854	L78M05MRB	5V REGULATOR	
IC855	LM317T	12V REGULATOR	
IC1201	SDA5255V61	MICRO PROCESSOR	
IC1202	MN1381-R(TA)	RESET	
IC1203	XL24C16P-2UA	EAROM *	
IC1204	RPM-637CBRS	RECEIVER	
IC3001	TEA6415C	VIDEO SWITCH	
IC3002	AN5862K	RGB SWITCHING	
IC3003	HEF4053B	SWITCHING I.C.	
IC3851	M62212P	DC CONVERTOR	
IC3852	MC3458P1	AMPLIFIER	
IC3853	AN78L08TA	8V REGULATOR	
IC3854	TL431ACLPM	REGULATOR	
FUSES			
F3801	2153.15H	FUSE	
F3851	19195/8	FUSE	
F38011	EYF52BC	FUSE HOLDER	
F38012	EYF52BC	FUSE HOLDER	
F38511	EYF52BC	FUSE HOLDER	
F38512	EYF52BC	FUSE HOLDER	
DIODES			
D101	MA858TA5	DIODE	
D102	MA858TA5	DIODE	
D103	MA858TA5	DIODE	
D104	MA165TA5	DIODE	
D303	MA165TA5	DIODE	
D351	MA165TA5	DIODE	
D352	MA165TA5	DIODE	
D353	MA165TA5	DIODE	
D354	MA165TA5	DIODE	
D451	ERA15-02V3	DIODE	
D454	MA165TA5	DIODE	
D456	1SR124-4AT82	DIODE	
D501	MA165TA5	DIODE	
D553	1SR124-4AT82	DIODE	
D554	ERA22-02V3	DIODE	
D555	MA165TA5	DIODE	
D556	MA4150	DIODE	
D557	MA4150	DIODE	
D559	MA165TA5	DIODE	
D560	ERA22-02V3	DIODE	
D561	EG01CV0	DIODE	

Cct Ref	Parts Number	Description
D601	MA165TA5	DIODE
D801	RBV4-08	DIODE
D805	1SR124-4AT82	DIODE
D806	1SR124-4AT82	DIODE
D807	1SR124-4AT82	DIODE
D808	1SR124-4AT82	DIODE
D809	1SR124-4AT82	DIODE
D811	1N4150T-77	DIODE
D812	MA165TA5	DIODE
D814	MTZJT-777.5B	DIODE
D815	MTZJT-777.5B	DIODE
D851	TVSRU3AMLFA5	DIODE
D852	TVSRU3AMLFA5	DIODE
D855	MA165TA5	DIODE
D856	1N4150T-77	DIODE
D857	1N4150T-77	DIODE
D858	MTZJT-775.6C	DIODE
D860	MA165TA5	DIODE
D861	1N4150T-77	DIODE
D863	1N4150T-77	DIODE
D864	MA165TA5	DIODE
D867	MA165TA5	DIODE
D868	R2KNLFA1	DIODE
D869	MA165TA5	DIODE
D870	MA165TA5	DIODE
D871	MA165TA5	DIODE
D872	MA165TA5	DIODE
D873	MA165TA5	DIODE
D874	MA165TA5	DIODE
D875	MA165TA5	DIODE
D876	MTZJT-775.1B	DIODE
D1201	MA700TA5	DIODE
D1202	MA165TA5	DIODE
D1206	LN81RPHL	DIODE
D1207	MTZJT-776.2A	DIODE
D1208	MA165TA5	DIODE
D1209	MA165TA5	DIODE
D1210	MA165TA5	DIODE
D1211	MA165TA5	DIODE
D1401	MTZJ33B	DIODE
D3001	MTZJT-775.1A	DIODE
D3002	MTZJT-775.1A	DIODE
D3003	MA165TA5	DIODE
D3004	MA165TA5	DIODE
D3005	MA165TA5	DIODE
D3006	MA165TA5	DIODE
D3007	MA165TA5	DIODE
D3008	MA165TA5	DIODE
D3010	UDZTE-1716B	DIODE
D3011	UDZTE-1716B	DIODE
D3012	UDZTE-1716B	DIODE
D3013	UDZTE-1716B	DIODE
D3803	MA165TA5	DIODE
D3804	MA165TA5	DIODE
D3807	MTZJT-7718C	DIODE
D3808	MTZJT-7730B	DIODE
D3851	RM4ZLF-L1	DIODE
D3853	TVSRU3AMLFA5	DIODE
D3854	TVSRU2AMLFA5	DIODE
D3855	MTZJT-7716C	DIODE
D3858	1SR124-4AT82	DIODE
D3859	TF341M-A-RL	THYRISTOR
D3861	1SS355TE-17	DIODE
TRANSISTORS		
Q010	BC847B	TRANSISTOR
Q101	BC847B	TRANSISTOR

Cct Ref	Parts Number	Description
Q253	BC847B	TRANSISTOR
Q340	BC847B	TRANSISTOR
Q351	2SC1473-RN	TRANSISTOR
Q352	2SC1473-RN	TRANSISTOR
Q353	2SC1473-RN	TRANSISTOR
Q354	BC857B	TRANSISTOR
Q451	BC847B	TRANSISTOR
Q452	BC847B	TRANSISTOR
Q501	BC857B	TRANSISTOR
Q502	BC847B	TRANSISTOR
Q551	BU2506DFRB	TRANSISTOR
Q552	2SC3941H	TRANSISTOR
Q553	BC847B	TRANSISTOR
Q601	BC857B	TRANSISTOR
Q602	BC847B	TRANSISTOR
Q801	BC847B	TRANSISTOR
Q802	2SD965-R	TRANSISTOR
Q851	2SC1317-TA	TRANSISTOR
Q852	BC847B	TRANSISTOR
Q853	BC847B	TRANSISTOR
Q854	BC847B	TRANSISTOR
Q855	BC857B	TRANSISTOR
Q1201	BC847B	TRANSISTOR
Q1203	BC847B	TRANSISTOR
Q1207	BC857B	TRANSISTOR
Q1208	BC847B	TRANSISTOR
Q1212	BC847B	TRANSISTOR
Q1213	BC847B	TRANSISTOR
Q1214	BC847B	TRANSISTOR
Q3001	BC847B	TRANSISTOR
Q3002	BC847B	TRANSISTOR
Q3003	BC847B	TRANSISTOR
Q3004	BC847B	TRANSISTOR
Q3005	BC847B	TRANSISTOR
Q3006	BC847B	TRANSISTOR
Q3007	2SC1318-S	TRANSISTOR
Q3008	2SC1318-S	TRANSISTOR
Q3009	BC847B	TRANSISTOR
Q3010	2SC1318-S	TRANSISTOR
Q3011	2SD1328STX	TRANSISTOR
Q3012	BC857B	TRANSISTOR
Q3013	BC857B	TRANSISTOR
Q3014	2SD1328STX	TRANSISTOR
Q3015	BC847B	TRANSISTOR
Q3016	BC847B	TRANSISTOR
Q3017	BC847B	TRANSISTOR
Q3018	BC847B	TRANSISTOR
Q3019	BC847B	TRANSISTOR
Q3020	BC847B	TRANSISTOR
Q3021	BC847B	TRANSISTOR
Q3851	BC847B	TRANSISTOR
Q3852	BC847B	TRANSISTOR
Q3853	2SA720-RS	TRANSISTOR
Q3854	2SC1318-S	TRANSISTOR
Q3855	2SK2779LF-H	TRANSISTOR
Q3857	BC847B	TRANSISTOR
Q3861	BC847B	TRANSISTOR
TRANSFORMERS		
T551	ETH19Y70AY	TRANSFORMER
T552	ZTFK33006A	F.B.T.
T801	ETS35AA496ND	TRANSFORMER
T802	ETP35KAN619U	TRANSFORMER
T3851	ETS35AA489ND	TRANSFORMER
COILS		
J111	EXCELSA35T	COIL
J128	EXCELSA35T	COIL

Cct Ref	Parts Number	Description
L010	EXCELSA35T	COIL
L011	EXCELSA35T	COIL
L012	TLTACT150K	COIL
L101	TLTACT4R7K	COIL
L451	EXCELSA35T	COIL
L551	ELH5L4109	COIL
L552	ELC08D682E	COIL
L601	ELJFB101KF	COIL
L801	EXCELD35V	COIL
L851	EXCELSA35T	COIL
L852	EXCELSA35T	COIL
L1201	EXCELSA35T	COIL
L1202	ERJNA6R8GF	COIL
L1203	TLTACT100K	COIL
L1204	TLTACT331K	COIL
L1205	EXCELSA35T	COIL
L3001	TLT100K991R	COIL
L3802	EXCELSA35T	COIL
L3803	EXCELSA35T	COIL
L3804	EXCELSA35T	COIL
L3805	EXCELSA35T	COIL
FILTERS		
L3801	ELF15N005A	LINE FILTER
X101	EFCS6R0MS5	FILTER
X102	EFCS5R5MS5	FILTER
X103	EFCS6R5MS5	FILTER
X301	TAFCSB503F6	FILTER
CRYSTALS		
X601	TSSA025	CRYSTAL
X602	LN-P-01S	CRYSTAL
X1201	CSA18.00MXZ	CRYSTAL
RESISTORS		
C1216	ERJ6GEY0R00	S.M.CARB 0.1W 5% 0 Ω
C1230	ERJ6GEY0R00	S.M.CARB 0.1W 5% 0 Ω
JA1	ERJ6GEY0R00	S.M.CARB 0.1W 5% 0 Ω
JA2	ERJ6GEY0R00	S.M.CARB 0.1W 5% 0 Ω
JA2	ERJ8GEY0R00	S.M.CARB .125W 5% 0 Ω
JA3	ERJ8GEY0R00	S.M.CARB .125W 5% 0 Ω
JA4	ERJ6GEY0R00	S.M.CARB 0.1W 5% 0 Ω
JA4	ERJ8GEY0R00	S.M.CARB .125W 5% 0 Ω
JA5	ERJ6GEY0R00	S.M.CARB 0.1W 5% 0 Ω
JA6	ERJ6GEY0R00	S.M.CARB 0.1W 5% 0 Ω
JA6	ERJ8GEY0R00	S.M.CARB .125W 5% 0 Ω
JA7	ERJ6GEY0R00	S.M.CARB 0.1W 5% 0 Ω
JA7	ERJ8GEY0R00	S.M.CARB .125W 5% 0 Ω
JA8	ERJ8GEY0R00	S.M.CARB .125W 5% 0 Ω
JA9	ERJ8GEY0R00	S.M.CARB .125W 5% 0 Ω
JA12	ERJ8GEY0R00	S.M.CARB .125W 5% 0 Ω
JA13	ERJ8GEY0R00	S.M.CARB .125W 5% 0 Ω
JA14	ERJ8GEY0R00	S.M.CARB .125W 5% 0 Ω
JA15	ERJ8GEY0R00	S.M.CARB .125W 5% 0 Ω
JA16	ERJ6GEY0R00	S.M.CARB 0.1W 5% 0 Ω
JA17	ERJ6GEY0R00	S.M.CARB 0.1W 5% 0 Ω
JA18	ERJ8GEY0R00	S.M.CARB .125W 5% 0 Ω
JA19	ERJ8GEY0R00	S.M.CARB .125W 5% 0 Ω
JA20	ERJ6GEY0R00	S.M.CARB 0.1W 5% 0 Ω
JA21	ERJ6GEY0R00	S.M.CARB 0.1W 5% 0 Ω
JA22	ERJ8GEY0R00	S.M.CARB .125W 5% 0 Ω
JA23	ERJ8GEY0R00	S.M.CARB .125W 5% 0 Ω
JA24	ERJ6GEY0R00	S.M.CARB 0.1W 5% 0 Ω
JA25	ERJ6GEY0R00	S.M.CARB 0.1W 5% 0 Ω
JA26	ERJ6GEY0R00	S.M.CARB 0.1W 5% 0 Ω
JA27	ERJ8GEY0R00	S.M.CARB .125W 5% 0 Ω
JA28	ERJ8GEY0R00	S.M.CARB .125W 5% 0 Ω
JA29	ERJ6GEY0R00	S.M.CARB 0.1W 5% 0 Ω

Cct Ref	Parts Number	Description
JA30	ERJ6GEY0R00	S.M.CARB 0.1W 5% 0 Ω
JA30	ERJ8GEY0R00	S.M.CARB .125W 5% 0 Ω
JA31	ERJ8GEY0R00	S.M.CARB .125W 5% 0 Ω
JA32	ERJ8GEY0R00	S.M.CARB .125W 5% 0 Ω
JA33	ERJ8GEY0R00	S.M.CARB .125W 5% 0 Ω
JA34	ERJ6GEY0R00	S.M.CARB 0.1W 5% 0 Ω
JA35	ERJ8GEY0R00	S.M.CARB .125W 5% 0 Ω
JA36	ERJ8GEY0R00	S.M.CARB .125W 5% 0 Ω
JA37	ERJ6GEY0R00	S.M.CARB 0.1W 5% 0 Ω
JA38	ERJ6GEY0R00	S.M.CARB 0.1W 5% 0 Ω
JA39	ERJ8GEY0R00	S.M.CARB .125W 5% 0 Ω
JA40	ERJ6GEY0R00	S.M.CARB 0.1W 5% 0 Ω
JA41	ERJ6GEY0R00	S.M.CARB 0.1W 5% 0 Ω
JA42	ERJ6GEY0R00	S.M.CARB 0.1W 5% 0 Ω
JA98	ERJ8GEY0R00	S.M.CARB .125W 5% 0 Ω
JA99	ERJ6GEY0R00	S.M.CARB 0.1W 5% 0 Ω
JSA5	ERJ6GEY0R00	S.M.CARB 0.1W 5% 0 Ω
JYS1	ERJ6GEY0R00	S.M.CARB 0.1W 5% 0 Ω
R010	ERJ6GEYJ101	S.M.CARB 0.1W 5% 100 Ω
R011	ERJ6GEYJ101	S.M.CARB 0.1W 5% 100 Ω
R012	ERJ6GEYJ153	S.M.CARB 0.1W 5% 15K Ω
R013	ERJ6GEY0R00	S.M.CARB 0.1W 5% 0 Ω
R014	ERJ6GEYJ824	S.M.CARB 0.1W 5% 820K Ω
R015	ERJ6GEYJ104	S.M.CARB 0.1W 5% 100K Ω
R102	ERJ6GEYJ562	S.M.CARB 0.1W 5% 5K6 Ω
R103	ERJ6GEYJ512	S.M.CARB 0.1W 5% 5K1 Ω
R104	ERJ6GEYJ512	S.M.CARB 0.1W 5% 5K1 Ω
R105	ERJ6GEYJ562	S.M.CARB 0.1W 5% 5K6 Ω
R106	ERJ6GEYJ102	S.M.CARB 0.1W 5% 1K Ω
R107	ERJ6GEYJ332	S.M.CARB 0.1W 5% 3K3 Ω
R108	ERJ6GEYJ302	S.M.CARB 0.1W 5% 3K Ω
R109	ERJ6GEYJ332	S.M.CARB 0.1W 5% 3K3 Ω
R110	ERJ6GEYJ182	S.M.CARB 0.1W 5% 1K8 Ω
R111	ERJ6GEYJ123	S.M.CARB 0.1W 5% 12K Ω
R114	ERJ6GEYJ562	S.M.CARB 0.1W 5% 5K6 Ω
R251	ERJ6GEYJ3R3	S.M.CARB 0.1W 5% 3R3 Ω
R252	ERJ6GEYJ682	S.M.CARB 0.1W 5% 6K8 Ω
R254	ERJ6GEYJ121	S.M.CARB 0.1W 5% 120 Ω
R255	ERJ6GEYJ181	S.M.CARB 0.1W 5% 180 Ω
R256	ERJ6GEYJ104	S.M.CARB 0.1W 5% 100K Ω
R257	ERJ6GEYJ332	S.M.CARB 0.1W 5% 3K3 Ω
R258	ERJ6GEYJ822	S.M.CARB 0.1W 5% 8K2 Ω
R259	ERJ1CJP120	FUSIBLE 1W 5% 12 Ω
R263	ERJ6GEYJ331	S.M.CARB 0.1W 5% 330 Ω
R301	ERJ6GEYJ102	S.M.CARB 0.1W 5% 1K Ω
R302	ERJ6GEYJ102	S.M.CARB 0.1W 5% 1K Ω
R303	ERJ6GEYJ472	S.M.CARB 0.1W 5% 4K7 Ω
R304	ERJ6GEYJ222	S.M.CARB 0.1W 5% 2K2 Ω
R305	ERJ6GEYJ753	S.M.CARB 0.1W 5% 75K Ω
R306	ERJ6GEYJ753	S.M.CARB 0.1W 5% 75K Ω
R307	ERJ6GEYJ271	S.M.CARB 0.1W 5% 270 Ω
R308	ERJ6GEYJ102	S.M.CARB 0.1W 5% 1K Ω
R309	ERJ6GEYJ271	S.M.CARB 0.1W 5% 270 Ω
R310	ERJ6GEYJ102	S.M.CARB 0.1W 5% 1K Ω
R311	ERJ6GEYJ271	S.M.CARB 0.1W 5% 270 Ω
R312	ERJ6GEYJ102	S.M.CARB 0.1W 5% 1K Ω
R340	ERJ6GEYJ101	S.M.CARB 0.1W 5% 100 Ω
R351	ERG1SJ123E	METAL 1W 5% 12K Ω
R352	ERG1SJ123E	METAL 1W 5% 12K Ω
R353	ERG1SJ123E	METAL 1W 5% 12K Ω
R366	ERJ6GEYJ821	S.M.CARB 0.1W 5% 820 Ω
R367	ERJ6GEYJ821	S.M.CARB 0.1W 5% 820 Ω
R368	ERJ6GEYJ821	S.M.CARB 0.1W 5% 820 Ω
R369	ERJ6GEYJ183	S.M.CARB 0.1W 5% 18K Ω
R370	ERJ6GEYJ183	S.M.CARB 0.1W 5% 18K Ω
R371	ERJ6GEYJ183	S.M.CARB 0.1W 5% 18K Ω

Cct Ref	Parts Number	Description				
R372	ERJ6GEYJ103	S.M.CARB	0.1W	5%	10K	🔊
R373	ERJ6GEYJ391	S.M.CARB	0.1W	5%	390	🔊
R374	ERJ6GEYJ103	S.M.CARB	0.1W	5%	10K	🔊
R375	ERDS1TJ152	CARBON	0.5W	5%	1K5	🔊
R386	ERDS1TJ152	CARBON	0.5W	5%	1K5	🔊
R387	ERDS1TJ152	CARBON	0.5W	5%	1K5	🔊
R401	ERJ6ENF1202	S.M.CARB	0.1W	1%	1K2	🔊
R407	ERJ6GEYJ223	S.M.CARB	0.1W	5%	22K	🔊
R451	ERJ6GEYJ1R0	S.M.CARB	0.1W	5%	1	🔊
R452	ERJ6GEYJ223	S.M.CARB	0.1W	5%	22K	🔊
R453	ERJ6GEYJ911	S.M.CARB	0.1W	5%	910	🔊
R454	ERJ6GEY0R00	S.M.CARB	0.1W	5%	0	🔊
R455	ERJ6ENF5602	S.M.CARB	0.1W	5%	56	🔊
R456	ERJ6ENF2002	S.M.CARB	0.1W	5%	2K	🔊
R457	ERJ6GEYJ103	S.M.CARB	0.1W	5%	10K	🔊
R458	ERDS1TJ471	CARBON	0.5W	5%	470	🔊
R460	ERJ6GEYJ332	S.M.CARB	0.1W	5%	3K3	🔊
R461	ERJ6GEYJ473	S.M.CARB	0.1W	5%	47K	🔊
R462	ERJ6GEYJ473	S.M.CARB	0.1W	5%	47K	🔊
R463	ERJ6GEYJ103	S.M.CARB	0.1W	5%	10K	🔊
R464	ERJ6GEYJ562	S.M.CARB	0.1W	5%	5K6	🔊
R465	ERDS1TJ102	CARBON	0.5W	5%	1K	🔊
R466	ERDS1TJ102	CARBON	0.5W	5%	1K	🔊
R468	ERDS1TJ222	CARBON	0.5W	5%	2K2	🔊
R469	ERJ6GEYJ223	S.M.CARB	0.1W	5%	22K	🔊
R470	ERJ6GEYJ223	S.M.CARB	0.1W	5%	22K	🔊
R471	ERDS1TJ1R2	CARBON	0.5W	5%	1R2	🔊
R473	ERJ6ENF1003	S.M.CARB	0.1W	5%	10	🔊
R501	ERJ6GEYJ224	S.M.CARB	0.1W	5%	220K	🔊
R502	ERJ6GEYJ224	S.M.CARB	0.1W	5%	220K	🔊
R503	ERJ6GEYJ102	S.M.CARB	0.1W	5%	1K	🔊
R504	ERJ6GEYJ561	S.M.CARB	0.1W	5%	560	🔊
R505	ERJ6GEYJ334	S.M.CARB	0.1W	5%	330K	🔊
R506	ERJ6GEYJ334	S.M.CARB	0.1W	5%	330K	🔊
R507	ERJ6GEYJ152	S.M.CARB	0.1W	5%	1K5	🔊
R508	ERJ6GEYJ152	S.M.CARB	0.1W	5%	1K5	🔊
R509	ERJ6GEYJ471	S.M.CARB	0.1W	5%	470	🔊
R510	ERJ6GEYJ105	S.M.CARB	0.1W	5%	1M	🔊
R511	ERJ6GEYJ105	S.M.CARB	0.1W	5%	1M	🔊
R512	ERJ6GEYJ102	S.M.CARB	0.1W	5%	1K	🔊
R551	ERF5ZJ150	WOUND	5W	5%	15	🔊
R554	ERG5SJS562H	METAL	5W	5%	5K6	🔊
R555	ERJ6GEYJ122	S.M.CARB	0.1W	5%	1K2	🔊
R556	ERJ6GEYJ222	S.M.CARB	0.1W	5%	2K2	🔊
R557	ERG3ANJP472H	METAL	3W	5%	4K7	🔊
R558	ERJ6GEYJ474	S.M.CARB	0.1W	5%	470K	🔊
R559	ERD25TJ333	CARBON	0.25W	5%	33K	🔊
R561	ERQ1CJP4R7	FUSIBLE	1W	5%	4R7	🔊
R562	ERO50PKF6803	METAL	0.5W	1%	68	🔊
R563	ERJ6ENF1602	S.M.CARB	0.1W	5%	1K6	🔊
R564	ERG2SJS273	METAL	2W	5%	27K	🔊
R565	ERG2ANJP682H	METAL	2W	5%	6K8	🔊
R566	ERQ14AJW151	FUSIBLE	0.25W	10%	150	🔊
R569	ERJ6GEYJ392	S.M.CARB	0.1W	5%	3K9	🔊
R570	ERJ6GEYJ102	S.M.CARB	0.1W	5%	1K	🔊
R571	ERJ6GEYJ102	S.M.CARB	0.1W	5%	1K	🔊
R573	ERX1SJ3R3	METAL	1W	5%	3R3	🔊
R575	ERDS1TJ304	CARBON	0.5W	5%	300K	🔊
R576	ERJ6GEYJ332	S.M.CARB	0.1W	5%	3K3	🔊
R601	ERJ6GEYJ395	S.M.CARB	0.1W	5%	3M9	🔊
R603	ERJ6GEYJ123	S.M.CARB	0.1W	5%	12K	🔊
R604	ERJ6GEYJ222	S.M.CARB	0.1W	5%	2K2	🔊
R605	ERJ6GEYJ223	S.M.CARB	0.1W	5%	22K	🔊
R606	ERJ6GEYJ222	S.M.CARB	0.1W	5%	2K2	🔊
R607	ERJ6GEYJ103	S.M.CARB	0.1W	5%	10K	🔊
R608	ERJ6GEYJ472	S.M.CARB	0.1W	5%	4K7	🔊

Cct Ref	Parts Number	Description				
R609	ERJ6GEYJ103	S.M.CARB	0.1W	5%	10K	🔊
R610	ERJ6GEYJ223	S.M.CARB	0.1W	5%	22K	🔊
R611	ERJ6GEYJ475	S.M.CARB	0.1W	5%	4M5	🔊
R802	ERDS1TJ224	CARBON	0.5W	5%	220K	🔊
R803	ERDS1TJ224	CARBON	0.5W	5%	220K	🔊
R804	ERQ12HJ150	FUSIBLE	0.1W	5%	15	🔊
R805	ERJ6GEYJ101	S.M.CARB	0.1W	5%	100	🔊
R806	ERW2PKR56	WOUND	2W	10%	R56	🔊
R807	ERG2ANJ101	METAL	0.5W	5%	100	🔊
R808	ERJ6GEYJ202	S.M.CARB	0.1W	5%	2K	🔊
R809	ERG12SJ561P	METAL	0.5W	5%	650	🔊
R810	ERG2SJ471	METAL	2W	5%	470	🔊
R812	ERD75TAJ825	CARBON	0.75W	5%	8M2	🔊
R819	ERJ6GEYJ102	S.M.CARB	0.1W	5%	1K	🔊
R820	ERDS1TJ560	CARBON	0.5W	5%	56	🔊
R851	ERD25TJ221	CARBON	0.25W	5%	220	🔊
R852	ERD25TJ272	CARBON	0.25W	5%	2K7	🔊
R855	ERJ6GEYJ302	S.M.CARB	0.1W	5%	3K	🔊
R856	ERJ6GEYJ102	S.M.CARB	0.1W	5%	1K	🔊
R857	ERD25TJ431	CARBON	0.25W	5%	430	🔊
R858	ERD25TJ121	CARBON	0.25W	5%	120	🔊
R859	ERD25TJ202	CARBON	0.25W	5%	2K	🔊
R860	ERJ6GEYJ223	S.M.CARB	0.1W	5%	22K	🔊
R862	ERJ6GEYJ104	S.M.CARB	0.1W	5%	100K	🔊
R863	ERJ6GEYJ333	S.M.CARB	0.1W	5%	33K	🔊
R864	ERJ6GEYJ103	S.M.CARB	0.1W	5%	10K	🔊
R865	ERG2ANJ150	METAL	2W	5%	15	🔊
R866	ERG2ANJ270	METAL	2W	5%	27	🔊
R867	ERG2FJ330H	METAL	2W	5%	33	🔊
R868	ERJ6GEYJ102	S.M.CARB	0.1W	5%	1K	🔊
R869	ERJ6GEYJ102	S.M.CARB	0.1W	5%	1K	🔊
R870	ERJ6GEYJ102	S.M.CARB	0.1W	5%	1K	🔊
R871	ERJ6GEYJ102	S.M.CARB	0.1W	5%	1K	🔊
R873	ERG2FJ560H	METAL	2W	5%	56	🔊
R1201	ERJ6GEYJ103	S.M.CARB	0.1W	5%	10K	🔊
R1202	ERJ6GEYJ101	S.M.CARB	0.1W	5%	100	🔊
R1203	ERJ6GEYJ562	S.M.CARB	0.1W	5%	5K6	🔊
R1204	ERJ6GEYJ101	S.M.CARB	0.1W	5%	100	🔊
R1205	ERJ6GEYJ562	S.M.CARB	0.1W	5%	5K6	🔊
R1206	ERJ6GEYJ101	S.M.CARB	0.1W	5%	100	🔊
R1207	ERJ6GEYJ101	S.M.CARB	0.1W	5%	100	🔊
R1208	ERJ6GEYJ101	S.M.CARB	0.1W	5%	100	🔊
R1209	ERJ6GEYJ101	S.M.CARB	0.1W	5%	100	🔊
R1210	ERJ6GEYJ101	S.M.CARB	0.1W	5%	100	🔊
R1211	ERJ6GEYJ101	S.M.CARB	0.1W	5%	100	🔊
R1212	ERJ6GEYJ330	S.M.CARB	0.1W	5%	33	🔊
R1213	ERJ6GEYJ101	S.M.CARB	0.1W	5%	100	🔊
R1214	ERJ6GEYJ101	S.M.CARB	0.1W	5%	100	🔊
R1215	ERJ6GEYJ101	S.M.CARB	0.1W	5%	100	🔊
R1216	ERJ6GEYJ101	S.M.CARB	0.1W	5%	100	🔊
R1217	ERJ6GEYJ101	S.M.CARB	0.1W	5%	100	🔊
R1218	ERJ6GEYJ103	S.M.CARB	0.1W	5%	10K	🔊
R1219	ERJ6GEYJ473	S.M.CARB	0.1W	5%	47K	🔊
R1220	ERJ6GEYJ822	S.M.CARB	0.1W	5%	8K2	🔊
R1221	ERJ6GEYJ225	S.M.CARB	0.1W	5%	2M2	🔊
R1222	ERJ6GEYJ682	S.M.CARB	0.1W	5%	6K8	🔊
R1223	ERJ6GEYJ682	S.M.CARB	0.1W	5%	6K8	🔊
R1224	ERJ6GEYJ823	S.M.CARB	0.1W	5%	82K	🔊
R1225	ERJ6GEYJ474	S.M.CARB	0.1W	5%	470K	🔊
R1226	ERJ6GEY0R00	S.M.CARB	0.1W	5%	0	🔊
R1227	ERJ6GEYJ101	S.M.CARB	0.1W	5%	100	🔊
R1228	ERJ6GEYJ101	S.M.CARB	0.1W	5%	100	🔊
R1229	ERJ6GEYJ472	S.M.CARB	0.1W	5%	4K7	🔊
R1230	ERJ6GEYJ563	S.M.CARB	0.1W	5%	56K	🔊
R1231	ERJ6GEYJ101	S.M.CARB	0.1W	5%	100	🔊
R1232	ERJ6GEYJ101	S.M.CARB	0.1W	5%	100	🔊

Cct Ref	Parts Number	Description				
R1233	ERJ6GEYJ101	S.M.CARB	0.1W	5%	100	Ω
R1234	ERJ6GEYJ562	S.M.CARB	0.1W	5%	5K6	Ω
R1235	ERJ6GEYJ101	S.M.CARB	0.1W	5%	100	Ω
R1236	ERJ6GEYJ562	S.M.CARB	0.1W	5%	5K6	Ω
R1237	ERJ6GEYJ101	S.M.CARB	0.1W	5%	100	Ω
R1238	ERJ6GEYJ103	S.M.CARB	0.1W	5%	10K	Ω
R1239	ERJ6GEYJ102	S.M.CARB	0.1W	5%	1K	Ω
R1240	ERJ6GEYJ101	S.M.CARB	0.1W	5%	100	Ω
R1241	ERJ6GEYJ101	S.M.CARB	0.1W	5%	100	Ω
R1242	ERJ6GEYJ101	S.M.CARB	0.1W	5%	100	Ω
R1243	ERJ6GEYJ471	S.M.CARB	0.1W	5%	470	Ω
R1244	ERJ6GEYJ471	S.M.CARB	0.1W	5%	470	Ω
R1245	ERJ6GEYJ471	S.M.CARB	0.1W	5%	470	Ω
R1246	ERJ6GEYJ222	S.M.CARB	0.1W	5%	2K2	Ω
R1247	ERJ6GEYJ102	S.M.CARB	0.1W	5%	1K	Ω
R1248	ERJ6GEYJ103	S.M.CARB	0.1W	5%	10K	Ω
R1251	ERJ6GEYJ271	S.M.CARB	0.1W	5%	270	Ω
R1252	ERJ6GEYJ562	S.M.CARB	0.1W	5%	5K6	Ω
R1253	ERJ6GEYJ562	S.M.CARB	0.1W	5%	5K6	Ω
R1254	ERJ6GEYJ562	S.M.CARB	0.1W	5%	5K6	Ω
R1255	ERJ6GEYJ562	S.M.CARB	0.1W	5%	5K6	Ω
R1256	ERJ6GEYJ102	S.M.CARB	0.1W	5%	1K	Ω
R1257	ERJ6GEYJ562	S.M.CARB	0.1W	5%	5K6	Ω
R1258	ERJ6GEYJ562	S.M.CARB	0.1W	5%	5K6	Ω
R1259	ERJ6GEYJ562	S.M.CARB	0.1W	5%	5K6	Ω
R1260	ERJ6GEYJ562	S.M.CARB	0.1W	5%	5K6	Ω
R1261	ERJ6GEYJ562	S.M.CARB	0.1W	5%	5K6	Ω
R1262	ERJ6GEYJ152	S.M.CARB	0.1W	5%	1K5	Ω
R1263	ERJ6GEYJ102	S.M.CARB	0.1W	5%	1K	Ω
R1264	ERJ6GEYJ562	S.M.CARB	0.1W	5%	5K6	Ω
R1266	ERJ6GEYJ102	S.M.CARB	0.1W	5%	1K	Ω
R1267	ERJ6GEYJ102	S.M.CARB	0.1W	5%	1K	Ω
R1268	ERJ6GEYJ103	S.M.CARB	0.1W	5%	10K	Ω
R1269	ERJ6GEYJ470	S.M.CARB	0.1W	5%	47	Ω
R1270	ERJ6GEYJ103	S.M.CARB	0.1W	5%	10K	Ω
R1272	ERJ6GEYJ470	S.M.CARB	0.1W	5%	47	Ω
R1273	ERJ6GEYJ103	S.M.CARB	0.1W	5%	10K	Ω
R1274	ERJ6GEYJ822	S.M.CARB	0.1W	5%	8K2	Ω
R1275	ERJ6GEYJ470	S.M.CARB	0.1W	5%	47	Ω
R1276	ERJ6GEYJ103	S.M.CARB	0.1W	5%	10K	Ω
R1278	ERJ6GEYJ101	S.M.CARB	0.1W	5%	100	Ω
R1279	ERJ6GEYJ182	S.M.CARB	0.1W	5%	1K8	Ω
R1280	ERJ6GEYJ101	S.M.CARB	0.1W	5%	100	Ω
R1281	ERJ6GEYJ101	S.M.CARB	0.1W	5%	100	Ω
R1282	ERJ6GEYJ562	S.M.CARB	0.1W	5%	5K6	Ω
R1283	ERJ6GEY0R00	S.M.CARB	0.1W	5%	0	Ω
R1284	ERJ6GEYJ562	S.M.CARB	0.1W	5%	5K6	Ω
R1285	ERJ6GEYJ103	S.M.CARB	0.1W	5%	10K	Ω
R1286	ERJ6GEYJ392	S.M.CARB	0.1W	5%	3K9	Ω
R1287	ERJ6GEYJ752	S.M.CARB	0.1W	5%	7K5	Ω
R1401	ERJ6GEYJ333	S.M.CARB	0.1W	5%	33K	Ω
R3001	ERJ6GEYJ101	S.M.CARB	0.1W	5%	100	Ω
R3003	ERJ6GEYJ470	S.M.CARB	0.1W	5%	47	Ω
R3004	ERJ6GEYJ750	S.M.CARB	0.1W	5%	75	Ω
R3005	ERJ6GEYJ101	S.M.CARB	0.1W	5%	100	Ω
R3006	ERJ6GEYJ104	S.M.CARB	0.1W	5%	100K	Ω
R3007	ERJ6GEYJ470	S.M.CARB	0.1W	5%	47	Ω
R3009	ERJ6GEYJ562	S.M.CARB	0.1W	5%	5K6	Ω
R3010	ERJ6GEYJ562	S.M.CARB	0.1W	5%	5K6	Ω
R3011	ERJ6GEYJ750	S.M.CARB	0.1W	5%	75	Ω
R3012	ERJ6GEYJ563	S.M.CARB	0.1W	5%	56K	Ω
R3013	ERJ6GEYJ104	S.M.CARB	0.1W	5%	100K	Ω
R3014	ERJ6GEYJ750	S.M.CARB	0.1W	5%	75	Ω
R3015	ERJ6GEYJ750	S.M.CARB	0.1W	5%	75	Ω
R3016	ERJ6GEYJ750	S.M.CARB	0.1W	5%	75	Ω
R3017	ERJ6GEYJ221	S.M.CARB	0.1W	5%	220	Ω

Cct Ref	Parts Number	Description				
R3018	ERJ6GEYJ181	S.M.CARB	0.1W	5%	180	Ω
R3020	ERJ6GEYJ470	S.M.CARB	0.1W	5%	47	Ω
R3021	ERJ6GEYJ104	S.M.CARB	0.1W	5%	100K	Ω
R3022	ERJ6GEYJ104	S.M.CARB	0.1W	5%	100K	Ω
R3023	ERJ6GEYJ102	S.M.CARB	0.1W	5%	1K	Ω
R3024	ERJ6GEYJ562	S.M.CARB	0.1W	5%	5K6	Ω
R3025	ERJ6GEYJ183	S.M.CARB	0.1W	5%	18K	Ω
R3026	ERJ6GEYJ222	S.M.CARB	0.1W	5%	2K2	Ω
R3027	ERJ6GEYJ222	S.M.CARB	0.1W	5%	2K2	Ω
R3028	ERJ6GEYJ102	S.M.CARB	0.1W	5%	1K	Ω
R3029	ERJ6GEYJ562	S.M.CARB	0.1W	5%	5K6	Ω
R3030	ERJ6GEYJ102	S.M.CARB	0.1W	5%	1K	Ω
R3031	ERJ6GEYJ102	S.M.CARB	0.1W	5%	1K	Ω
R3032	ERJ6GEYJ243	S.M.CARB	0.1W	5%	24K	Ω
R3033	ERJ6GEYJ473	S.M.CARB	0.1W	5%	47K	Ω
R3034	ERJ6GEYJ680	S.M.CARB	0.1W	5%	68	Ω
R3035	ERJ6GEYJ471	S.M.CARB	0.1W	5%	470	Ω
R3036	ERJ6GEYJ471	S.M.CARB	0.1W	5%	470	Ω
R3037	ERJ6GEYJ471	S.M.CARB	0.1W	5%	470	Ω
R3038	ERJ6GEYJ680	S.M.CARB	0.1W	5%	68	Ω
R3039	ERJ6GEYJ471	S.M.CARB	0.1W	5%	470	Ω
R3040	ERJ6GEYJ471	S.M.CARB	0.1W	5%	470	Ω
R3041	ERJ6GEYJ471	S.M.CARB	0.1W	5%	470	Ω
R3042	ERJ6GEYJ680	S.M.CARB	0.1W	5%	68	Ω
R3043	ERJ6GEYJ750	S.M.CARB	0.1W	5%	75	Ω
R3044	ERJ6GEYJ750	S.M.CARB	0.1W	5%	75	Ω
R3045	ERJ6GEYJ243	S.M.CARB	0.1W	5%	24K	Ω
R3046	ERJ6GEYJ183	S.M.CARB	0.1W	5%	18K	Ω
R3047	ERJ6GEYJ680	S.M.CARB	0.1W	5%	68	Ω
R3048	ERJ6GEYJ101	S.M.CARB	0.1W	5%	100	Ω
R3049	ERDS1TJ750	CARBON	0.5W	5%	75	Ω
R3051	ERJ6GEYJ332	S.M.CARB	0.1W	5%	3K3	Ω
R3052	ERJ6GEYJ153	S.M.CARB	0.1W	5%	15K	Ω
R3053	ERJ6GEYJ221	S.M.CARB	0.1W	5%	220	Ω
R3054	ERJ6GEYJ222	S.M.CARB	0.1W	5%	2K2	Ω
R3055	ERJ6GEYJ182	S.M.CARB	0.1W	5%	1K8	Ω
R3056	ERJ6GEYJ122	S.M.CARB	0.1W	5%	1K2	Ω
R3057	ERJ6GEYJ101	S.M.CARB	0.1W	5%	100	Ω
R3058	ERJ6GEYJ471	S.M.CARB	0.1W	5%	470	Ω
R3059	ERJ6GEYJ471	S.M.CARB	0.1W	5%	470	Ω
R3060	ERJ6GEYJ103	S.M.CARB	0.1W	5%	10K	Ω
R3061	ERJ6GEYJ101	S.M.CARB	0.1W	5%	100	Ω
R3062	ERJ6GEYJ101	S.M.CARB	0.1W	5%	100	Ω
R3063	ERDS1TJ750	CARBON	0.5W	5%	75	Ω
R3064	ERJ6GEYJ221	S.M.CARB	0.1W	5%	220	Ω
R3065	ERJ6GEYJ222	S.M.CARB	0.1W	5%	2K2	Ω
R3066	ERJ6GEYJ182	S.M.CARB	0.1W	5%	1K8	Ω
R3067	ERJ6GEYJ122	S.M.CARB	0.1W	5%	1K2	Ω
R3068	ERJ6GEYJ101	S.M.CARB	0.1W	5%	100	Ω
R3071	ERJ6GEYJ681	S.M.CARB	0.1W	5%	680	Ω
R3072	ERJ6GEYJ101	S.M.CARB	0.1W	5%	100	Ω
R3073	ERJ6GEYJ104	S.M.CARB	0.1W	5%	100K	Ω
R3074	ERJ6GEYJ101	S.M.CARB	0.1W	5%	100	Ω
R3075	ERJ6GEYJ101	S.M.CARB	0.1W	5%	100	Ω
R3076	ERJ6GEYJ101	S.M.CARB	0.1W	5%	100	Ω
R3077	ERJ6GEYJ101	S.M.CARB	0.1W	5%	100	Ω
R3078	ERJ6GEYJ101	S.M.CARB	0.1W	5%	100	Ω
R3079	ERJ6GEYJ101	S.M.CARB	0.1W	5%	100	Ω
R3080	ERJ6GEYJ680	S.M.CARB	0.1W	5%	68	Ω
R3081	ERJ6GEYJ273	S.M.CARB	0.1W	5%	27K	Ω
R3082	ERJ6GEYJ103	S.M.CARB	0.1W	5%	10K	Ω
R3083	ERJ6GEYJ563	S.M.CARB	0.1W	5%	56K	Ω
R3084	ERJ6GEYJ563	S.M.CARB	0.1W	5%	56K	Ω
R3085	ERJ6GEYJ563	S.M.CARB	0.1W	5%	56K	Ω
R3086	ERJ6GEYJ563	S.M.CARB	0.1W	5%	56K	Ω
R3087	ERJ6GEYJ683	S.M.CARB	0.1W	5%	68K	Ω

Cct Ref	Parts Number	Description				
R3088	ERJ6GEYJ512	S.M.CARB	0.1W	5%	5K1	🔌
R3089	ERJ6GEYJ563	S.M.CARB	0.1W	5%	56K	🔌
R3090	ERJ6GEYJ183	S.M.CARB	0.1W	5%	18K	🔌
R3091	ERJ6GEYJ243	S.M.CARB	0.1W	5%	24K	🔌
R3092	ERJ6GEYJ562	S.M.CARB	0.1W	5%	5K6	🔌
R3093	ERJ6GEYJ563	S.M.CARB	0.1W	5%	56K	🔌
R3094	ERJ8GEYJ391	S.M.CAR	.125	5%	390	🔌
R3095	ERJ6GEYJ101	S.M.CARB	0.1W	5%	100	🔌
R3096	ERJ6GEYJ101	S.M.CARB	0.1W	5%	100	🔌
R3097	ERJ6GEYJ101	S.M.CARB	0.1W	5%	100	🔌
R3098	ERJ6GEYJ101	S.M.CARB	0.1W	5%	100	🔌
R3099	ERJ6GEYJ101	S.M.CARB	0.1W	5%	100	🔌
R3101	ERJ6GEYJ101	S.M.CARB	0.1W	5%	100	🔌
R3102	ERJ6GEYJ101	S.M.CARB	0.1W	5%	100	🔌
R3103	ERJ6GEYJ101	S.M.CARB	0.1W	5%	100	🔌
R3104	ERG2SJS100H	METAL	2W	5%	100	🔌
R3106	ERJ6GEYJ470	S.M.CARB	0.1W	5%	47	🔌
R3107	ERJ6GEYJ750	S.M.CARB	0.1W	5%	75	🔌
R3108	ERJ6GEYJ103	S.M.CARB	0.1W	5%	10K	🔌
R3109	ERJ6GEYJ222	S.M.CARB	0.1W	5%	2K2	🔌
R3110	ERJ6GEYJ103	S.M.CARB	0.1W	5%	10K	🔌
R3111	ERJ6GEYJ681	S.M.CARB	0.1W	5%	680	🔌
R3112	ERJ6GEYJ103	S.M.CARB	0.1W	5%	10K	🔌
R3113	ERJ6GEYJ103	S.M.CARB	0.1W	5%	10K	🔌
R3114	ERJ6GEYJ101	S.M.CARB	0.1W	5%	100	🔌
R3115	ERJ6GEYJ273	S.M.CARB	0.1W	5%	27K	🔌
R3116	ERJ6GEYJ561	S.M.CARB	0.1W	5%	560	🔌
R3117	ERJ6GEYJ152	S.M.CARB	0.1W	5%	1K5	🔌
R3118	ERJ6GEYJ273	S.M.CARB	0.1W	5%	27K	🔌
R3119	ERJ6GEYJ101	S.M.CARB	0.1W	5%	100	🔌
R3120	ERJ6GEYJ153	S.M.CARB	0.1W	5%	15K	🔌
R3121	ERJ6GEYJ681	S.M.CARB	0.1W	5%	680	🔌
R3201	ERJ6GEYJ221	S.M.CARB	0.1W	5%	220	🔌
R3202	ERJ6GEYJ221	S.M.CARB	0.1W	5%	220	🔌
R3203	ERJ6GEYJ221	S.M.CARB	0.1W	5%	220	🔌
R3204	ERJ6GEYJ562	S.M.CARB	0.1W	5%	5K6	🔌
R3205	ERJ6GEYJ750	S.M.CARB	0.1W	5%	75	🔌
R3207	ERJ6GEYJ562	S.M.CARB	0.1W	5%	5K6	🔌
R3801	ERC12ZGK335D	SOLID	0.5W	10%	3M3	🔌
R3802	ERF5ZK2R7	WOUND	5W	20%	2R7	🔌 ⚠️
R3807	ERJ6GEYJ242	S.M.CARB	0.1W	5%	2K4	🔌
R3808	ERJ6ENF1802	S.M.CARB	0.1W	5%	1K8	🔌
R3809	ERJ6ENF1001	S.M.CARB	0.1W	1%	1K	🔌
R3810	ERO25CKF6201	METAL	0.25W	1%	6K2	🔌 ⚠️
R3811	ERO25CKF1802	METAL	0.25W	1%	18K	🔌 ⚠️
R3813	ERJ6GEYJ562	S.M.CARB	0.1W	5%	5K6	🔌
R3818	ERDS1TJ182	CARBON	0.5W	10%	1K8	🔌
R3819	ERJ6GEYJ103	S.M.CARB	0.1W	5%	10K	🔌
R3821	ERJ6GEYJ152	S.M.CARB	0.1W	5%	1K5	🔌
R3852	ERDS1TJ182	CARBON	0.5W	10%	1K8	🔌
R3856	ERJ6GEYJ182	S.M.CARB	0.1W	5%	1K8	🔌
R3859	ERD25TJ102	CARBON	0.25W	5%	1K	🔌
R3860	ERDS1TJ472	CARBON	0.5W	5%	4K7	🔌
R3861	ERDS1TJ472	CARBON	0.5W	5%	4K7	🔌
R3862	ERJ6GEYJ303	S.M.CARB	0.1W	5%	30K	🔌
R3863	ERJ6GEYJ513	S.M.CARB	0.1W	5%	51K	🔌
R3864	ERO50PHF5102	METAL	0.5W	1%	51	🔌 ⚠️
R3865	ERN55EB5600P	METAL	0.25W	0%1	56	🔌
R3867	ERDS1TJ154	CARBON	0.5W	5%	150	🔌
R3868	ERDS1TJ473	CARBON	0.5W	5%	47K	🔌
R3869	ERDS1TJ122	CARBON	0.5W	5%	1K2	🔌
R3870	EVMEASA00B14	CONTROL			10K	🔌
R3871	ERC12GK105D	SOLID	0.5W	10%	1M	🔌
R4001	ERJ6GEYJ681	S.M.CARB	0.1W	5%	680	🔌
CAPACITORS						
C010	ECA1CM220GB	ELECT	16V		22µF	

Cct Ref	Parts Number	Description				
C011	ECUV1H103KBX	S.M. CAP	50V		10nF	
C012	ECUV1H100CCX	S.M. CAP	50V		10pF	
C013	ECUV1H100CCX	S.M. CAP	50V		10pF	
C014	ECA1HM101GB	ELECT	50V		100µF	
C017	ECA1HM101GB	ELECT	50V		100µF	
C018	ECA1HM010GB	ELECT	50V		1µF	
C019	ECA1HM101GB	ELECT	50V		100µF	
C020	ECUV1H104ZFX	S.M. CAP	50V		100nF	
C022	ECUV1H220JCX	S.M. CAP	50V		22pF	
C023	ECUV1H220JCX	S.M. CAP	50V		22pF	
C024	ECUV1H104ZFX	S.M. CAP	50V		100nF	
C025	ECA1HM101GB	ELECT	50V		100µF	
C101	ECUV1H103KBX	S.M. CAP	50V		10nF	
C102	ECA1HM010GB	ELECT	50V		1µF	
C103	ECA1HMR47GB	ELECT	50V		1µF	
C210	ECA1CM100GB	ELECT	16V		10µF	
C211	ECUV1H272KBX	S.M. CAP	50V		2.7nF	
C251	ECQM1H224J	FILM	50V		220nF	
C252	ECUV1H272KBX	S.M. CAP	50V		2.7nF	
C253	ECUV1H104ZFX	S.M. CAP	50V		100nF	
C254	ECQM1H684J	FILM	50V		680nF	
C255	ECA1EM102GB	ELECT	25V		100µF	
C256	ECA1EM470GB	ELECT	25V		47µF	
C257	ECUV1H471JCX	S.M. CAP	50V		470pF	
C258	ECA1EM100GB	ELECT	25V		0.1µF	
C259	ECA1HM010GB	ELECT	50V		1µF	
C260	ECA1EM471GB	ELECT	25V		470µF	
C301	ECA1HM101GB	ELECT	50V		100µF	
C302	ECUV1H104ZFX	S.M. CAP	50V		100nF	
C303	ECUV1H104ZFX	S.M. CAP	50V		100nF	
C304	ECA1CM471GB	ELECT	16V		470µF	
C305	ECA1HM010GB	ELECT	50V		1µF	
C306	ECUV1H103KBX	S.M. CAP	50V		10nF	
C307	ECUV1H104ZFX	S.M. CAP	50V		100nF	
C308	ECUV1H103KBX	S.M. CAP	50V		10nF	
C309	ECA1HM101GB	ELECT	50V		100µF	
C310	ECUV1H104ZFX	S.M. CAP	50V		100nF	
C311	ECA1HM010GB	ELECT	50V		1µF	
C312	ECUV1H104ZFX	S.M. CAP	50V		100nF	
C313	ECUV1H104ZFX	S.M. CAP	50V		100nF	
C314	ECEA1HNR47UB	ELECT	50V		100nF	
C315	ECEA1HNR47UB	ELECT	50V		100nF	
C316	ECEA1HN2R2	ELECT	50V		100nF	
C317	ECUV1H104ZFX	S.M. CAP	50V		100nF	
C351	ECUV1H151JCX	S.M. CAP	50V		150pF	
C352	ECUV1H151JCX	S.M. CAP	50V		150pF	
C353	ECUV1H181JCX	S.M. CAP	50V		180pF	
C355	ECKC3D152J	CERAMIC	2KV		1.5nF	⚠️
C357	ECKC2H152J	CERAMIC	500V		1.5nF	⚠️
C362	ECUV1H102ZFX	S.M. CAP	50V		1nF	
C368	ECEA2EU010	ELECT	250V		1µF	
C370	ECA1CM220GB	ELECT	16V		22µF	
C371	ECA1CM221GB	ELECT	16V		220µF	
C401	ECA1HM010GB	ELECT	50V		1µF	
C402	ECUV1H103KBX	S.M. CAP	50V		10nF	
C451	ECQM1H274J	FILM	50V		270nF	
C452	ECUV1H100DCX	S.M. CAP	50V		10pF	
C453	ECEA1HU101	ELECT	50V		100µF	
C454	ECKC1H472J	CERAMIC	50V		4.7nF	
C456	ECA1EM222B	ELECT	25V		2.2nF	
C457	ECA1EM102GB	ELECT	25V		100µF	
C458	ECA1HM2R2GB	ELECT	50V		2.2µF	
C459	ECKC2H471J	CERAMIC	500V		470pF	⚠️
C460	ECA1EM222B	ELECT	25V		2.2nF	
C461	ECEA1HGE4R7	ELECT	50V		2.2nF	
C501	ECUV1H223KBX	S.M. CAP	50V		22nF	

Cct Ref	Parts Number	Description			
C502	ECEA1HN010	ELECT	50V	1μF	
C503	ECUV1H391JCX	S.M. CAP	50V	390pF	
C504	ECEA1HN2R2	ELECT	50V	390pF	
C551	ECKC3D821JB	CERAMIC	2KV	390pF	⚠
C552	ECWH20392JVY	FILM	200V	39nF	
C554	ECKC2H152J	CERAMIC	500V	1.5nF	⚠
C555	ECEA2EU100	ELECT	250V	10μF	
C556	ECKC2H471J	CERAMIC	500V	470pF	⚠
C557	ECA1EM102GB	ELECT	25V	100μF	
C558	ECKC2H471J	CERAMIC	500V	470pF	⚠
C559	ECEA2EU100	ELECT	250V	10μF	
C560	ECA2CM010B	ELECT	160V	1pF	
C561	ECA1CM100GB	ELECT	16V	10μF	
C562	ECA1HHG330B	ELECT	50V	33pF	
C563	ECWF2H274J	FILM	500V	270nF	⚠
C564	ECEA2CGR47	ELECT	160V	270nF	
C570	ECA2VM2R2B	ELECT	350V	2.2μF	
C571	ECUV1H101JCX	S.M. CAP	50V	100pF	
C601	ECUV1H473KBX	S.M. CAP	50V	47nF	
C602	ECUV1H220JCX	S.M. CAP	50V	22pF	
C603	ECA1HM010GB	ELECT	50V	1μF	
C604	ECUV1H153KBX	S.M. CAP	50V	15nF	
C605	ECUV1H103KBX	S.M. CAP	50V	10nF	
C606	ECUV1H104ZFX	S.M. CAP	50V	100nF	
C607	ECUV1H104ZFX	S.M. CAP	50V	100nF	
C608	ECUV1H104ZFX	S.M. CAP	50V	100nF	
C609	ECUV1H104ZFX	S.M. CAP	50V	100nF	
C610	ECA1HM101GB	ELECT	50V	100μF	
C611	ECUV1H470JCX	S.M. CAP	50V	47pF	
C612	ECUV1H470JCX	S.M. CAP	50V	47pF	
C613	ECUV1H103KBX	S.M. CAP	50V	10nF	
C614	ECUV1H103KBX	S.M. CAP	50V	10nF	
C615	ECUV1H104ZFX	S.M. CAP	50V	100nF	
C616	ECA1HM101GB	ELECT	50V	100μF	
C617	222236576104	FILM	760V	100nF	
C618	B32529-C224	FILM	50V	220nF	
C619	ECUV1H103KBX	S.M. CAP	50V	10nF	
C620	ECUV1H560JCX	S.M. CAP	50V	56pF	
C621	ECUV1H560JCX	S.M. CAP	50V	56pF	
C622	ECUV1H560JCX	S.M. CAP	50V	56pF	
C623	ECUV1H560JCX	S.M. CAP	50V	56pF	
C624	ECUV1H560JCX	S.M. CAP	50V	56pF	
C625	ECA1CM102B	ELECT	16V	56pF	
C802	ECKC2H472J	CERAMIC	500V	4.7nF	⚠
C803	ECKC2H472J	CERAMIC	500V	4.7nF	⚠
C804	ECKC2H472J	CERAMIC	500V	4.7nF	⚠
C805	ECKC2H472J	CERAMIC	500V	4.7nF	⚠
C806	ECOS2GA101BB	ELECT	400V	100μF	
C807	ECA1JM100GB	ELECT	63V	10μF	
C808	ECQB1H683K	FILM	50V	68nF	
C809	ECKC3D222JB	CERAMIC	2KV	68nF	⚠
C810	ECA1VM470B	ELECT	35V	47μF	
C815	ECKWNA332MEC	CERAMIC	250V	3.3nF	
C850	ECUV1H104ZFX	S.M. CAP	50V	100nF	
C851	ECKC2H471J	CERAMIC	500V	470pF	⚠
C852	ECEA1EGE102	ELECT	25V	470pF	
C853	ECKC2H471J	CERAMIC	500V	470pF	⚠
C854	ECA2CHG101E	ELECT	160V	100μF	
C856	ECUV1H104ZFX	S.M. CAP	50V	100nF	
C857	ECA1EM471GB	ELECT	25V	470μF	
C858	ECA1EM101GB	ELECT	25V	100μF	
C859	ECA1EM102GB	ELECT	25V	100μF	
C860	ECA1CM471GB	ELECT	16V	470μF	
C861	ECA1HM101GB	ELECT	50V	100μF	
C862	ECUV1H104ZFX	S.M. CAP	50V	100nF	
C863	ECA1HM101GB	ELECT	50V	100μF	

Cct Ref	Parts Number	Description			
C864	ECUV1H104ZFX	S.M. CAP	50V	100nF	
C865	ECA1HM101GB	ELECT	50V	100μF	
C866	ECUV1H104ZFX	S.M. CAP	50V	100nF	
C867	ECA1HM101GB	ELECT	50V	100μF	
C868	ECEA1EGE102	ELECT	25V	100μF	
C869	ECA1EHG102B	ELECT	25V	100μF	
C872	ECA1CM100GB	ELECT	16V	10μF	
C1201	ECUV1H471JCX	S.M. CAP	50V	470pF	
C1202	ECUV1H471JCX	S.M. CAP	50V	470pF	
C1203	ECUV1H471JCX	S.M. CAP	50V	470pF	
C1204	ECUV1H471JCX	S.M. CAP	50V	470pF	
C1205	ECA0JM101G	ELECT	6.3V	100μF	
C1206	ECUV1H104ZFX	S.M. CAP	50V	100nF	
C1207	ECUV1H150JCX	S.M. CAP	50V	15pF	
C1208	ECUV1H560JCX	S.M. CAP	50V	56pF	
C1209	222236516154	FILM	160V	150nF	
C1210	ECUV1H333KBX	S.M. CAP	50V	33nF	
C1211	ECUV1H333KBX	S.M. CAP	50V	33nF	
C1212	ECUV1H104ZFX	S.M. CAP	50V	100nF	
C1213	ECA1HM101GB	ELECT	50V	100μF	
C1215	ECQM1H334J	FILM	50V	330nF	
C1217	ECA1HM010GB	ELECT	50V	1μF	
C1218	ECUV1H104ZFX	S.M. CAP	50V	100nF	
C1219	ECA1HM101GB	ELECT	50V	100μF	
C1220	ECUV1H470GCG	S.M. CAP	50V	47pF	
C1221	ECUV1H390GCG	S.M. CAP	50V	47pF	
C1222	ECUV1H471JCX	S.M. CAP	50V	470pF	
C1223	ECUV1H560JCX	S.M. CAP	50V	56pF	
C1224	ECUV1H561JCX	S.M. CAP	50V	560pF	
C1225	ECA1CM100GB	ELECT	16V	10μF	
C1226	ECA0JM101G	ELECT	6.3V	100μF	
C1227	ECUV1H104ZFX	S.M. CAP	50V	100nF	
C1228	ECUV1H331JCX	S.M. CAP	50V	330pF	
C1229	ECUV1H104ZFX	S.M. CAP	50V	100nF	
C1231	ECUV1H471JCX	S.M. CAP	50V	470pF	
C1232	ECUV1H104KBX	S.M. CAP	50V	100nF	
C3001	ECUV1H101JCX	S.M. CAP	50V	100pF	
C3002	ECEA1HNR47UB	ELECT	50V	100pF	
C3003	ECUV1H224ZFX	S.M. CAP	50V	220nF	
C3006	ECUV1H102JCX	S.M. CAP	50V	1nF	
C3007	ECA1HM101GB	ELECT	50V	100μF	
C3008	ECEA1HNR47UB	ELECT	50V	100μF	
C3009	ECUV1H224ZFX	S.M. CAP	50V	220nF	
C3010	ECEA1CN470	ELECT	16V	47μF	
C3011	ECEA1HNR47UB	ELECT	50V	47μF	
C3012	ECA1HM470GB	ELECT	50V	47μF	
C3013	ECUV1H104ZFX	S.M. CAP	50V	100nF	
C3014	ECUV1H121JCX	S.M. CAP	50V	120pF	
C3015	ECUV1H104ZFX	S.M. CAP	50V	100nF	
C3016	ECA1HM470GB	ELECT	50V	47μF	
C3017	ECA1HM101GB	ELECT	50V	100μF	
C3018	ECA1HM101GB	ELECT	50V	100μF	
C3019	ECA1HM101GB	ELECT	50V	100μF	
C3020	ECA1HM470GB	ELECT	50V	47μF	
C3021	ECA1HM101GB	ELECT	50V	100μF	
C3022	ECUV1H561JCX	S.M. CAP	50V	560pF	
C3023	ECUV1H104ZFX	S.M. CAP	50V	100nF	
C3024	ECA1HM101GB	ELECT	50V	100μF	
C3025	ECEA1CN100	ELECT	16V	10μF	
C3026	ECEA1CN100	ELECT	16V	10μF	
C3027	ECA1HM2R2GB	ELECT	50V	2.2μF	
C3028	ECA1HM2R2GB	ELECT	50V	2.2μF	
C3029	ECA1HM2R2GB	ELECT	50V	2.2μF	
C3030	ECUV1H104ZFX	S.M. CAP	50V	100nF	
C3031	ECA1HM101GB	ELECT	50V	100μF	
C3032	ECUV1H104ZFX	S.M. CAP	50V	100nF	

Cct Ref	Parts Number	Description		
C3033	ECUV1H104ZFX	S.M. CAP	50V	100nF
C3034	ECUV1H104ZFX	S.M. CAP	50V	100nF
C3036	ECUV1H121JCX	S.M. CAP	50V	120pF
C3037	ECEA1HN2R2	ELECT	50V	120pF
C3038	ECEA1HN2R2	ELECT	50V	120pF
C3039	ECA1HM100GB	ELECT	50V	10µF
C3040	ECEA1HN2R2	ELECT	50V	10µF
C3041	ECEA1HN2R2	ELECT	50V	10µF
C3042	ECEA1HN2R2UB	ELECT	50V	2.2µF
C3043	ECUV1H104ZFX	S.M. CAP	50V	100nF
C3044	ECA1HM101GB	ELECT	50V	100µF
C3045	ECA1CM100GB	ELECT	16V	10µF
C3046	ECUV1H224ZFX	S.M. CAP	50V	220nF
C3047	ECEA1HNR47UB	ELECT	50V	220nF
C3048	ECQM1H224J	FILM	50V	220nF
C3049	ECUV1H104ZFX	S.M. CAP	50V	100nF
C3050	ECA1HM101GB	ELECT	50V	100µF
C3052	ECUV1H101JCX	S.M. CAP	50V	100pF
C3053	ECEA1HN2R2	ELECT	50V	100pF
C3054	ECUV1H680JCX	S.M. CAP	50V	68pF
C3201	ECUV1H103KBX	S.M. CAP	50V	10nF
C3202	ECEA1HN3R3UB	ELECT	50V	3R3µF
C3203	ECA1HM4R7GB	ELECT	50V	4.7µF
C3204	ECUV1H561JCX	S.M. CAP	50V	560pF
C3801	ECQU2A823MNB	FILM	200V	82nF
C3803	ECQE4225KFB	FILM	400V	82nF
C3804	ECA1HM101GB	ELECT	50V	100µF
C3807	ECEA1HU101	ELECT	50V	100µF
C3808	ECUV1H104KBX	S.M. CAP	50V	100nF
C3810	ECA1VM470B	ELECT	35V	47µF
C3811	ECEA1HU101	ELECT	50V	100µF
C3850	ECHS1221FZ3	FILM	100V	2.2pF
C3852	ECEA1HU101	ELECT	50V	100µF
C3853	ECA1EM101GB	ELECT	25V	100µF
C3854	ECHS1101FZ3	FILM	100V	10nF
C3855	ECA1CM220GB	ELECT	16V	22µF
C3856	ECUV1H821JCX	S.M. CAP	50V	22µF
C3857	ECUV1H152JCX	S.M. CAP	50V	1.5pF
C3858	ECKC2H102J	CERAMIC	500V	1nF
C3859	ECEA1EGE102	ELECT	25V	1nF
C3860	ECKC3A102J	CERAMIC	1KV	1nF
C3861	ECA2CM221E	ELECT	160V	220µF
C3866	ECA1HM222E	ELECT	50V	2.2nF
J31	ECQM1H104J	FILM	50V	100nF
TERMINALS AND LINKS				
JK3001	TJB8E020	AC/DC MODULE		
JK3002	P2325	BNC SOCKET		
JK3201	TJB16663	A.V. TERMINAL		
JK3202	TJB8E022	S-VHS TERMINAL		
R813	TSF19401	FS LINK		
R3822	TSF19252	FS LINK		
SWITCHES				
S451	EVQRDSL12	SWITCH		
S801	ESB99258S	POWER SWITCH		
S1201	EVQ23405R	SWITCH		
S1202	EVQ23405R	SWITCH		
S1203	EVQ23405R	SWITCH		
S1204	EVQ23405R	SWITCH		

Cct Ref	Parts Number	Description
---------	--------------	-------------

NOTES

A large rectangular area with a solid top and bottom border and horizontal dashed lines inside, intended for writing notes.

SCHEMATIC DIAGRAMS FOR MODEL

TX-G10

(AC1 CHASSIS)

IMPORTANT SAFETY NOTICE

Components identified by  mark have special characteristics important for safety. When replacing any of these components, use only manufacturer's specified parts.

NOTE

1. RESISTOR

All resistors are carbon 1/4W resistor, unless marked otherwise.
Unit of resistance is OHM (Ω) (k=1,000, M=1,000,000)

2. CAPACITORS

All capacitors are ceramic 50V unless marked otherwise.
Unit of capacitance is μ F unless otherwise stated.

3. COIL

Unit of inductance is μ H, unless otherwise stated.

4. TEST POINT

 Test Point Position

5. EARTH SYMBOL

 Chassis Earth (Cold)

 Line Earth (Hot)

6. VOLTAGE MEASUREMENT

Voltage is measured by a d.c. voltmeter.

Measurement conditions are as follows:

Power source	a.c. 220V-240V, 50Hz
Receiving Signal	Colour Bar signal (RF)
All customer controls	Maximum position

7.

 Indicates the Video signal path

 Indicates the Audio signal path

These schematic diagrams are the latest at time of printing and are subject to change without notice.

REMARKS

- Do not touch the hot part, or the hot and cold parts at the same time, as you are liable to a shock hazard.
- Do not short circuit the hot and cold circuits as electrical components may be damaged.
- Do not connect an instrument, such as an oscilloscope, to the hot and cold circuits simultaneously as this may cause fuse failure. Connect the earth of the instruments to the earth connection of the circuit being measured.
- Make sure to disconnect the power plug before removing the chassis.

NOTE

- The Power Supply Circuit contains a circuit area, which uses a separate power supply to isolate the earth connection. The circuit is defined by HOT and COLD indications in the schematic diagram. All circuits, except the Power Circuit, are COLD.

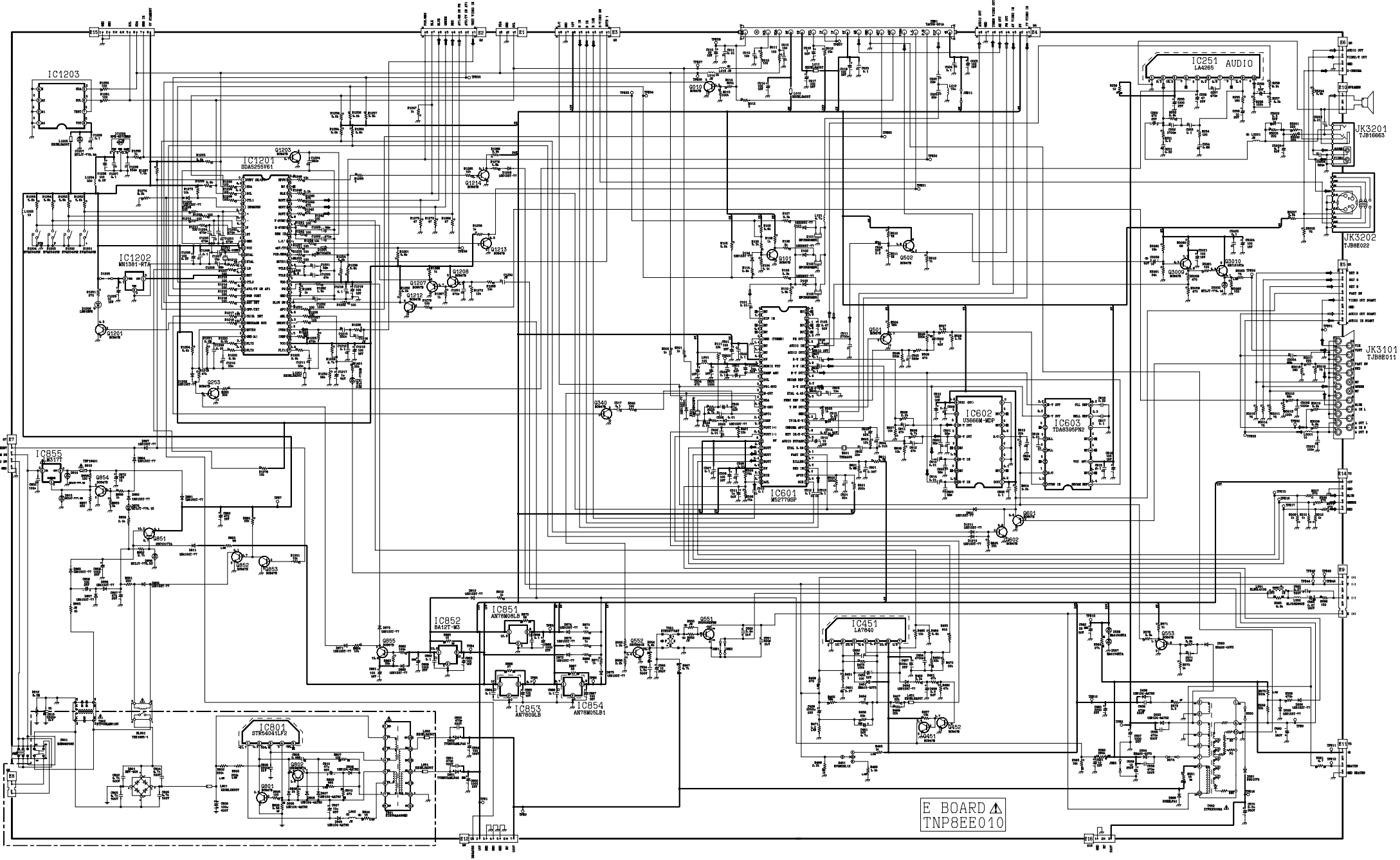

E BOARD ▲
TNP8EE010

JK3201
TJ816663

JK3202
TJ886022

JK3101
TJ88E011

Q BOARD 
TNP8EQ01

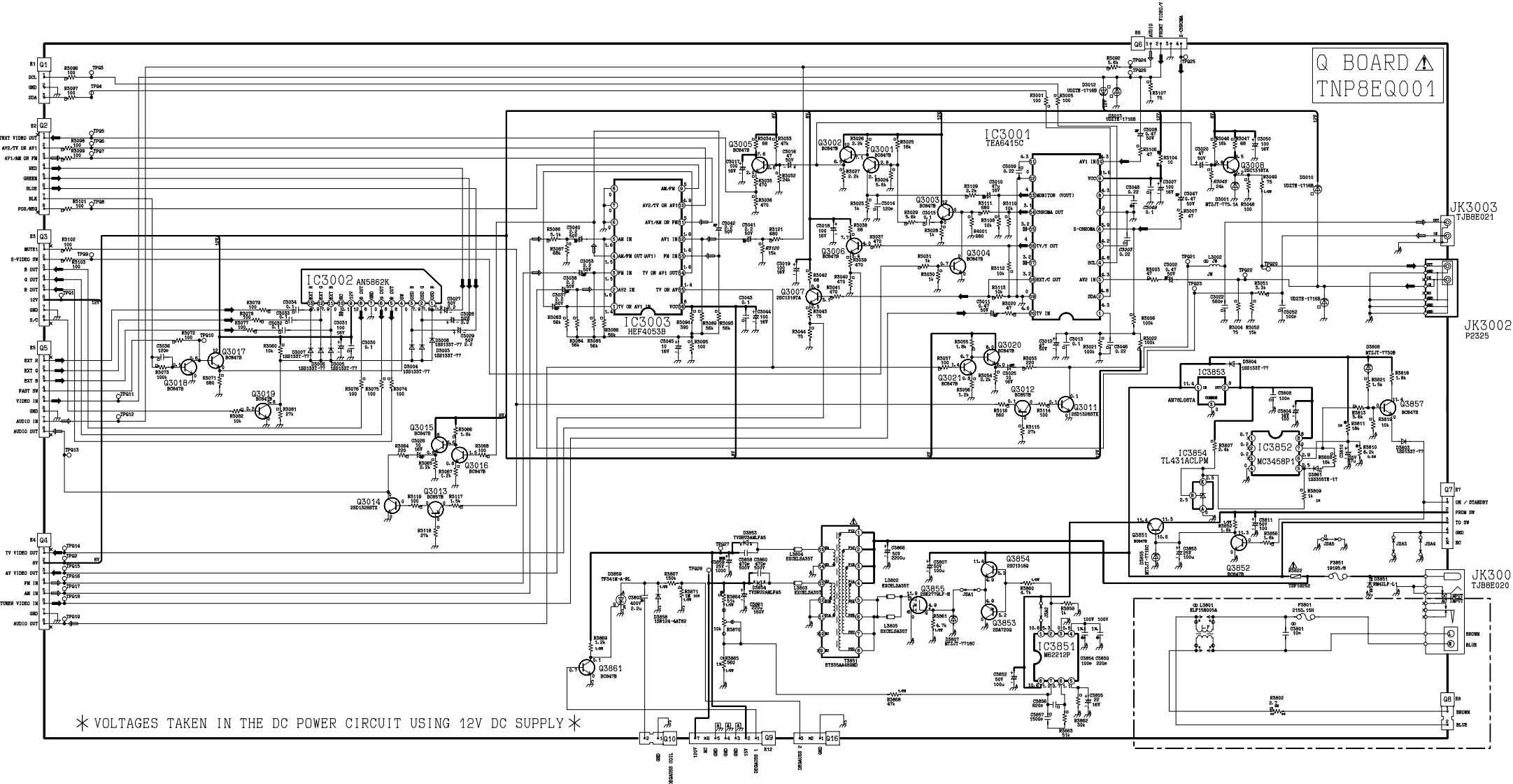

JK3003
TUB8E021

JK3002
P2325

JK3001
TUB8E020

* VOLTAGES TAKEN IN THE DC POWER CIRCUIT USING 12V DC SUPPLY *

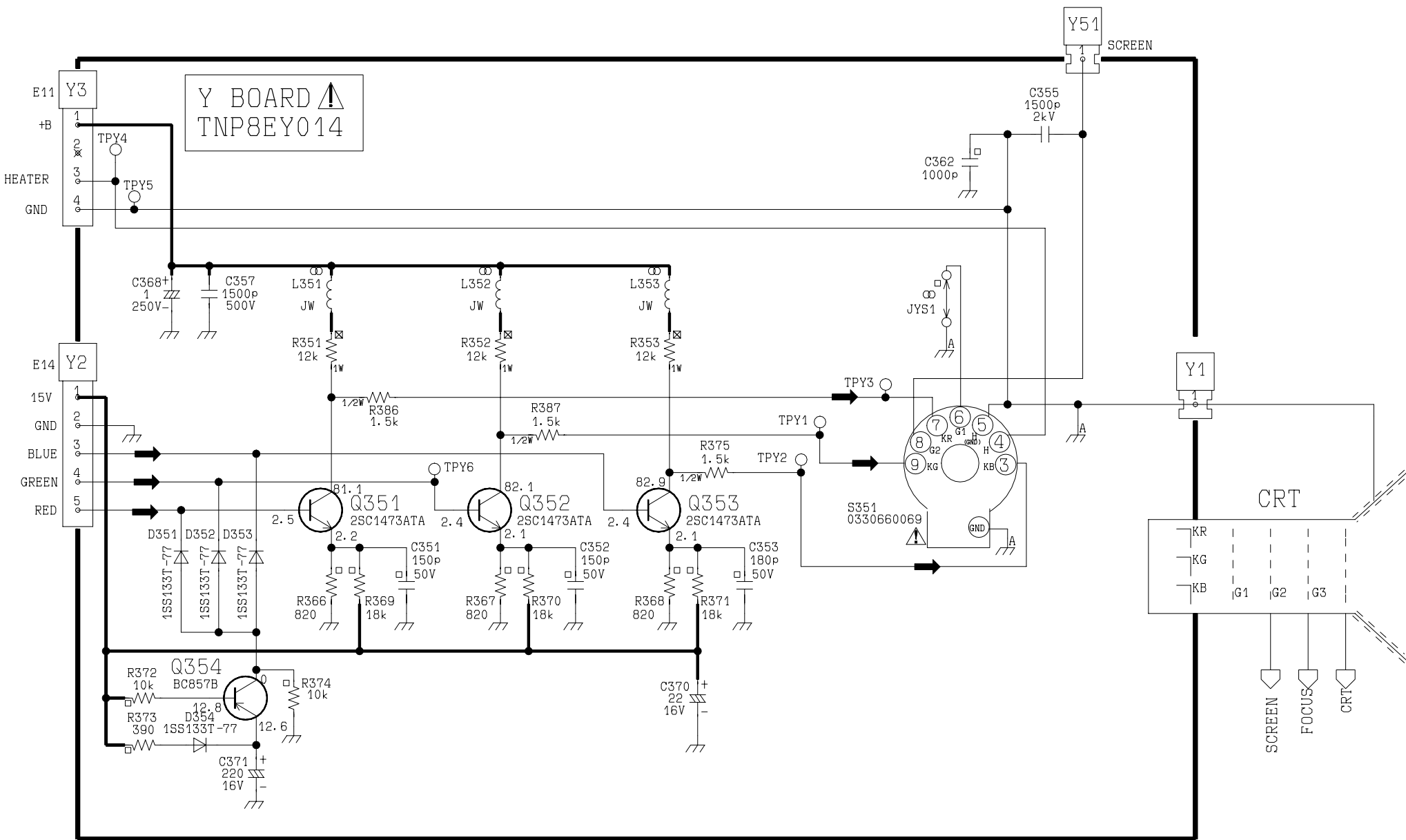

CONDUCTOR VIEWS

E - BOARD TNP8EE010

TRANS			
Q010	C6	D554	D6
Q040	C5	D555	D7
Q101	B5	D556	D6
Q251	C4	D557	D6
Q252	C4	D559	E7
Q253	C3	D560	C7
Q401	C6	D561	F7
Q402	C6	D801	D2
Q451	D7	D805	E4
Q452	D7	D806	E4
Q501	B6	D807	E4
Q502	A5	D808	F4
Q551	F6	D809	E4
Q552	F5	D811	C3
Q601	B7	D812	C5
Q602	A6	D814	C2
Q801	F4	D815	C2
Q802	F4	D851	D4
Q851	C2	D852	D4
Q852	E2	D855	E2
Q853	F2	D857	F2
Q854	C3	D858	D2
Q1201	F2	D860	D2
Q1202	B4	D861	C2
Q1203	B3	D863	E2
Q1207	A3	D864	E2
Q1208	A3	D867	E2
Q1209	B2	D868	D5
Q1212	A3	D870	C3
Q1213	A4	D871	C3
Q1214	A5	D872	C4
Q3009	B7	D873	C4
Q3010	B7	D874	C4
DIODES	D875	C4	TPE63 A5
D010	C6	D876	D2
I.C.'s			
D101	B5	D1201	A4
D102	B5	D1202	B4
D103	B5	D1205	B3
D104	B5	D1206	F2
D301	C7	D1207	B4
D302	C7	D1208	B4
D303	B6	D1209	B3
D451	D6	D1210	A5
D454	D7	D1211	A5
D456	E7	D1401	A3
D501	C6	T.P.'s	IC1201 B3
D551	F6	TPE1	D4
D552	E5	TPE2	D5
D553	E6	TPE3	D3

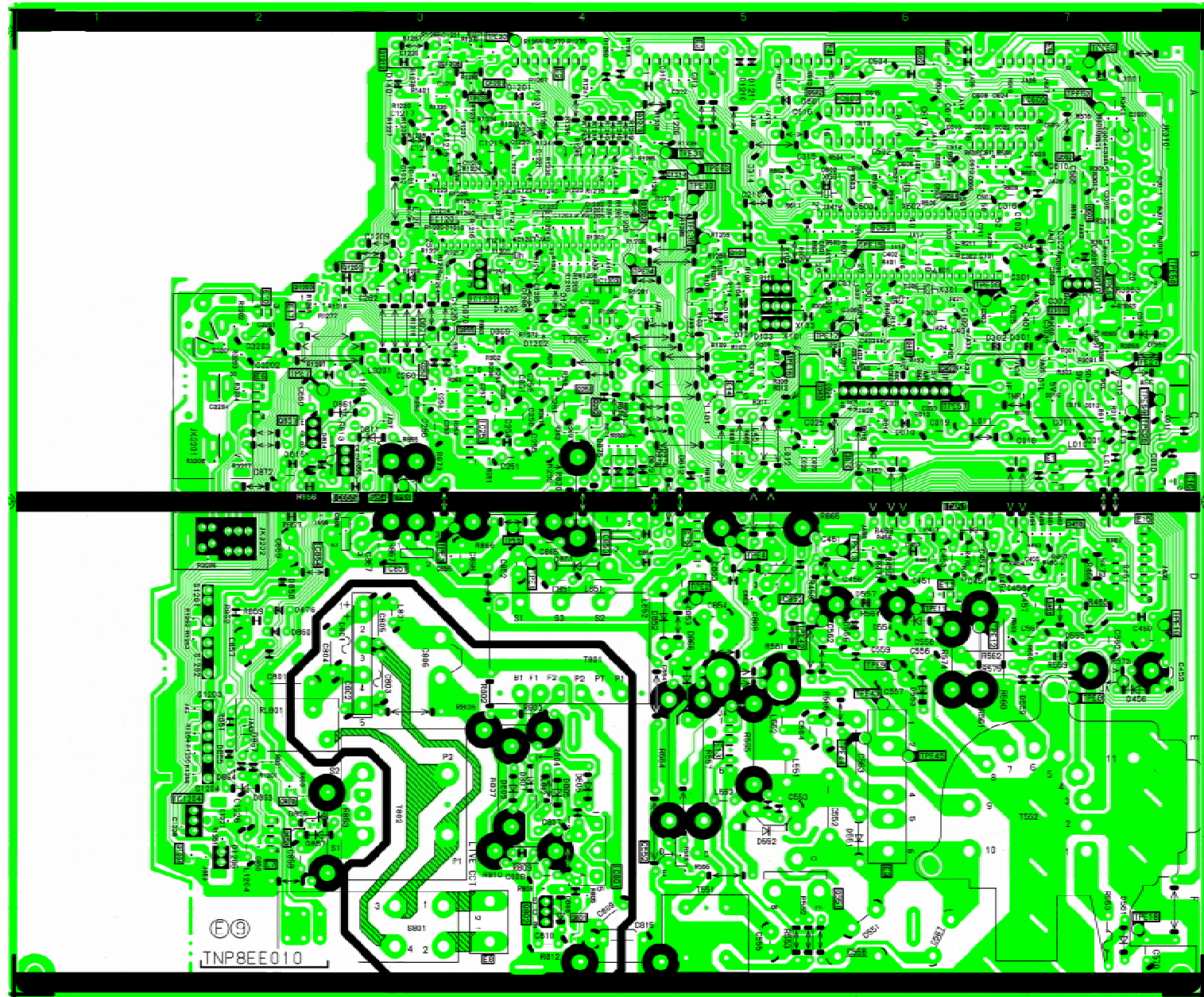

DIODES		
D3001	C4	TPQ22 A4
D3003	E2	TPQ23 B4
D3004	E4	TPQ24 B4
D3005	B1	TPQ25 B4
D3006	E4	TPQ26 B4
D3007	E4	TPQ27 E2
D3008	E4	TPQ28 E2
D3010	B4	I.C.'s
D3011	A4	IC3001 C4
D3012	B4	IC3002 E1
D3013	B4	IC3003 E4
D3804	D3	IC3851 C3
D3806	E3	IC3852 D3
D3807	C3	IC3853 D3
D3808	E3	IC3854 D3
D3851	B3	TRANS
D3853	D2	Q3001 D4
D3854	D3	Q3002 D4
D3858	E1	Q3003 D4
D3860	E3	Q3004 D4
D3861	D3	Q3005 D4
D3862	D3	Q3006 C5
TEST POINTS		
TPQ1	D5	Q3008 D4
TPQ2	B4	Q3011 B5
TPQ3	B4	Q3013 C5
TPQ4	B4	Q3014 C5
TPQ5	E4	Q3015 C5
TPQ6	E4	Q3016 C5
TPQ7	E4	Q3017 E5
TPQ8	E5	Q3018 E5
TPQ9	D5	Q3019 D5
TPQ10	E5	Q3020 B4
TPQ11	B5	Q3021 B5
TPQ12	B5	Q3851 C3
TPQ13	B5	Q3852 B3
TPQ14	C4	Q3853 C3
TPQ15	C4	Q3854 C2
TPQ16	D5	Q3855 C3
TPQ17	C5	Q3856 E3
TPQ18	C5	Q3857 E4
TPQ19	C5	Q3861 D1
TPQ20	A4	
TPQ21	B5	

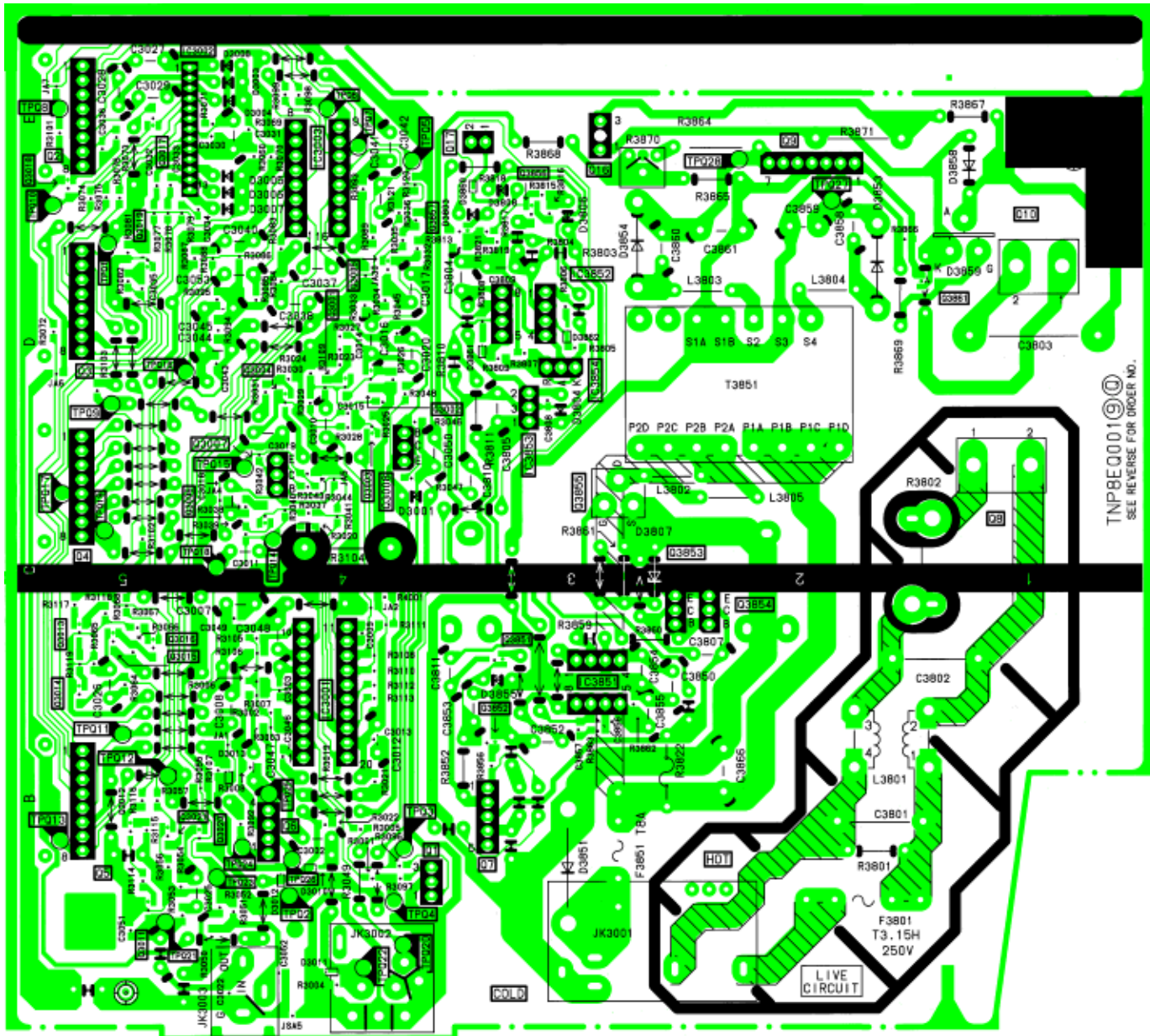

TNP8EQ001
SEE REVERSE FOR ORDER NO.

Y - BOARD TNP8EY014

DIODES	
D351	B1
D352	B1
D353	B1
D354	A1
TP'S	
TPY1	A1
TPY2	B2
TPY3	A1
TPY4	B2
TPY5	A2
TPY6	B1
TRAN'S	
Q351	B1
Q352	A1
Q353	B2
Q354	A1

